



U.S. Department
of Transportation
**Federal Aviation
Administration**

Introduction to **TCAS II** Version 7.1

Feb 28, 2011

HC-111358

Preface

This booklet provides the background for a better understanding of the Traffic Alert and Collision Avoidance System (TCAS II) by personnel involved in the implementation and operation of TCAS II. This booklet is an update of the TCAS II Version 7.0 manual published in 2000 by the Federal Aviation Administration (FAA). It describes changes to the CAS logic introduced by Version 7.1 and updates the information on requirements for use of TCAS II and operational experience.

Version 7.1 logic changes will improve TCAS Resolution Advisory (RA) sense reversal logic in vertical chase situations. In addition all "Adjust Vertical Speed, Adjust" RAs are converted to "Level-Off, Level-Off" RAs to make it more clear that a reduction in vertical rate is required.

The Minimum Operational Performance Standards (MOPS) for TCAS II Version 7.1 were approved in June 2008 and Version 7.1 units are expected to be operating by 2010-2011. Version 6.04a and 7.0 units are also expected to continue operating for the foreseeable future where authorized.

Preface.....	2
The TCAS Solution.....	5
Early Collision Avoidance Systems.....	5
TCAS II Development	6
Initial In-Service Evaluations	7
Version 6.0 / 6.04a Implementation.....	8
Version 7.0 Implementation.....	8
Version 7.1 Implementation.....	9
Requirements for World-Wide Carriage.....	9
RVSM Considerations	10
Standards and Guidance Material	10
TCAS II Components	11
TCAS Computer Unit	11
Mode S Transponder.....	11
Mode S/TCAS Control Panel.....	11
Antennas	12
Cockpit Presentation	12
Traffic Display	12
Traffic Display Symbology.....	13
Resolution Advisory (RA) Display.....	14
Target Surveillance	17
Mode S Surveillance	17
Mode C Surveillance.....	17
Interference Limiting	20
Electromagnetic Compatibility	20
Hybrid Surveillance	20
Collision Avoidance Concepts.....	22
Sensitivity Level	22
Tau	23
Protected Volume.....	26
CAS Logic Functions.....	26
Tracking	26
Traffic Advisory.....	28
Threat Detection.....	28
Resolution Advisory Selection	29

TCAS/TCAS Coordination.....	34
Air/Ground Communications.....	34
Traffic Advisory (TA) Display	35
Resolution Advisory (RA) Displays	35
Aural Annunciations	35
Performance Monitoring.....	37
Requirements for Use	37
Regulations and Operational Guidance	37
Training Programs	41
Operational Experience.....	42
Performance Monitoring Programs.....	42
Observed Performance.....	43
Summary	46
Abbreviations.....	47
Glossary	48
Bibliography	50

The TCAS Solution

After many years of extensive analysis, development, and flight evaluation by the Federal Aviation Administration (FAA), other countries' Civil Aviation Authorities (CAAs), and the aviation industry, Traffic Alert and Collision Avoidance System or TCAS was developed to reduce the risk of mid-air collisions between aircraft. **In the international arena, this system is known as the Airborne Collision Avoidance System or ACAS.**

TCAS is a family of airborne devices that function independently of the ground-based air traffic control (ATC) system, and provide collision avoidance protection for a broad spectrum of aircraft types. All TCAS systems provide some degree of collision threat alerting, and a traffic display. TCAS I and II differ primarily by their alerting capability.

TCAS I provides traffic advisories (TAs) to assist the pilot in the visual acquisition of intruder aircraft. TCAS I is mandated for use in the U.S. for turbine powered, passenger-carrying aircraft having more than 10 and less than 31 seats. TCAS I is also installed on a number of general aviation fixed wing aircraft and helicopters.

TCAS II provides TAs and resolution advisories (RAs), i.e., recommended escape maneuvers, in the vertical dimension to either increase or maintain the existing vertical separation between aircraft. TCAS II is mandated by the U.S. for commercial aircraft, including regional airline aircraft with more than 30 seats or a maximum takeoff weight greater than 33,000 lbs. Although not mandated for general aviation use, many turbine-powered general aviation aircraft and some helicopters are also equipped with TCAS II.

The TCAS concept makes use of the same radar beacon transponders installed on

aircraft to operate with ATC's ground-based radars. The level of protection provided by TCAS equipment depends on the type of transponder the target aircraft is carrying. The level of protection is outlined in Table 1. **It should be noted that TCAS provides no protection against aircraft that do not have an operating transponder.**

Table 1. TCAS Levels of Protection

		Own Aircraft Equipment	
		TCAS I	TCAS II
Target Aircraft Equipment	Mode A XPDR ONLY	TA	TA
	Mode C or Mode S XPDR	TA	TA and Vertical RA
	TCAS I	TA	TA and Vertical RA
	TCAS II	TA	TA and Coordinated Vertical RA

Early Collision Avoidance Systems

The 1956 collision between two airliners over the Grand Canyon spurred both the airlines and aviation authorities to initiate development of an effective collision avoidance system that would act as a last resort when there is a failure in the ATC-provided separation services. During the late 1950's and early 1960's, collision avoidance development efforts included an emphasis on passive and non-cooperating systems. These concepts proved to be impractical. One major operational problem that could not be overcome with these designs was the need for non-conflicting, complementary avoidance maneuvers which require a high-integrity communications link between aircraft involved in the conflict.

One of the most important collision avoidance concepts, attributed to Dr. John S. Morrell of Bendix, was the use of Tau which is the slant range between aircraft divided by the rate of closure or range rate. This concept is based on time, rather than distance, to the closest point of approach in an encounter.

During the late 1960's and early 1970's, several manufacturers developed aircraft collision avoidance systems based on interrogator/transponder and time/frequency techniques. Although these systems functioned properly during staged aircraft encounter testing, FAA and the airlines jointly concluded that in normal airline operations, they would generate a high rate of unnecessary alarms in dense terminal areas. This problem would have undermined the credibility of the system with the flight crews. In addition, each target aircraft would have needed to be equipped with the same equipment to provide protection to an equipped aircraft.

In the mid 1970's, the Beacon Collision Avoidance System (BCAS) was developed. BCAS used reply data from the Air Traffic Control Radar Beacon System (ATCRBS) transponders to determine an intruder's range and altitude. At that time, ATCRBS transponders were installed in all airline and military aircraft and a large number of general aviation aircraft. Thus, any BCAS-equipped aircraft would be able to detect and be protected against the majority of other aircraft in the air without imposing additional equipment requirements on those other aircraft. In addition, the discrete address communications techniques used in the Mode S transponders then under development permitted two conflicting BCAS aircraft to perform coordinated escape maneuvers with a high degree of reliability. In 1978, the collision between a light aircraft and an airliner over San Diego served to increase FAA's efforts to complete development of an effective collision avoidance system.

TCAS II Development

In 1981, FAA made a decision to develop and implement TCAS utilizing the basic BCAS design for interrogation and tracking with some additional capabilities. Like BCAS, TCAS is designed to work independently of the aircraft navigation equipment and the ground systems used to provide Air Traffic Control (ATC) services. TCAS interrogates ICAO compliant transponders of all aircraft in the vicinity and based on the replies received, tracks the slant range, altitude (when it is included in the reply message), and relative bearing of surrounding traffic. From several successive replies, TCAS calculates a time to reach the CPA (Closest Point of Approach) with the intruder, by dividing the range by the closure rate. This time value is the main parameter for issuing alerts. If the transponder replies from nearby aircraft include their altitude, TCAS also computes the time to reach co-altitude. TCAS can issue two types of alerts:

- Traffic Advisories (TAs) to assist the pilot in the visual search for the intruder aircraft and to prepare the pilot for a potential RA; and
- Resolution Advisories (RAs) to recommend maneuvers that will either increase or maintain the existing vertical separation from an intruder aircraft. When the intruder aircraft is also fitted with TCAS II, both TCAS' co-ordinate their RAs through the Mode S data link to ensure that complementary RAs are selected.

TCAS II was designed to operate in traffic densities of up to 0.3 aircraft per square nautical mile (nmi), i.e., 24 aircraft within a 5 nmi radius, which was the highest traffic density envisioned over the next 20 years.

Development of the TCAS II collision avoidance algorithms included the completion of millions of computer simulations to optimize the protection provided by the system, while minimizing

the frequency of unacceptable or nuisance advisories. In addition to these computer simulations, early versions of the collision avoidance algorithms were evaluated via pilot in the loop simulations and during the operation of prototype equipment in FAA aircraft throughout the NAS.

Extensive safety studies were also performed to estimate the safety improvements that could be expected with the introduction of TCAS into service. These safety studies have been continuously updated throughout the refinement of the collision avoidance algorithms. The safety studies have shown that TCAS II will resolve nearly all of the critical near mid-air collisions involving TCAS-equipped aircraft. However, TCAS cannot handle all situations. In particular, it is dependent on the accuracy of the threat aircraft's reported altitude and on the expectation that the threat aircraft will not maneuver in a manner that defeats the TCAS RA. Achieving adequate separation is also contingent on the pilot responding as the CAS logic expects. The safety study also showed that TCAS II will induce some critical near mid-air collisions, but overall, the number of near mid-air collisions with TCAS is less than ten percent of the number that would have occurred without the presence of TCAS.

Extensive studies were also carried out to evaluate the interaction between TCAS and ATC. The analysis of ATC radar data showed that in 90% of the cases, the vertical displacement required to resolve an RA was less than 300 feet. Based on these studies, it was concluded that the possibility of the response to a TCAS RA causing an aircraft to infringe on the protected airspace for another aircraft was remote.

Initial In-Service Evaluations

To ensure that TCAS performed as expected in its intended operational environment, several operational evaluations of the system have been conducted. These evaluations provided a means for the pilots using TCAS

and the controllers responsible for providing separation services to TCAS-equipped aircraft to have a direct influence on the final system design and performance requirements.

The initial operational evaluation of TCAS was conducted by Piedmont Airlines in 1982. Using a TCAS II prototype unit manufactured by Dalmo Victor, Piedmont flew approximately 900 hours in scheduled, revenue service while recording data on the performance of TCAS. These recorded data were analyzed to assess the frequency and suitability of the TAs and RAs. During this evaluation, the TCAS displays were not visible to the pilots, and observers from the aviation industry flew with the aircraft to monitor the system performance and to provide technical and operational comments on its design.

In 1987, Piedmont flew an upgraded version of the Dalmo Victor equipment for approximately 1200 hours. During this evaluation, the TCAS displays were visible to the pilots and the pilots were permitted to use the information provided to maneuver the aircraft in response to RAs. This installation included a dedicated TCAS data recorder so that quantitative data could be obtained on the performance of TCAS. In addition, pilots and observers completed questionnaires following each TA and RA so that assessments could be made regarding the utility of the system to the flight crews.

This evaluation also provided the basis for the development of avionics certification criteria for production equipment, validated pilot training guidelines, provided justification for improvements to the TCAS algorithms and displays, and validated pilot procedures for using the equipment.

Following the successful completion of the second Piedmont evaluation, FAA initiated the Limited Installation Program (LIP). Under the LIP, Bendix-King and Honeywell built and tested commercial quality, pre-production TCAS II equipment that was in compliance with the TCAS II Minimum

Operational Performance Standards (MOPS). Engineering flight tests of this equipment were conducted on the manufacturers' aircraft as well as FAA aircraft. Using data collected during these flight tests, along with data collected during factory and ground testing, both manufacturers' equipment were certified via a limited Supplemental Type Certificate (STC) for use in commercial revenue service.

The Bendix-King units were operated by United Airlines on a B737-200 and a DC8-73 aircraft. Northwest Airlines operated the Honeywell equipment on two MD-80 aircraft. Over 2000 hours of operating experience were obtained with the United aircraft and approximately 2500 hours of operating experience were obtained with the Northwest installations.

The experience provided by these operational evaluations resulted in further enhancements to the TCAS II logic, improved test procedures, and finalized the procedures for certification of production equipment. The most important information obtained from the operational evaluations was the nearly unanimous conclusion that TCAS II was safe, operationally effective, and ready for more widespread implementation.

Version 6.0 / 6.04a Implementation

In 1986 the collision between a DC-9 and a private aircraft over Cerritos, California resulted in a Congressional mandate (Public Law 100-223) that required some categories of U.S. and foreign aircraft to be equipped with TCAS II for flight operations in U.S. airspace. Based on Public Law 100-223, FAA issued a rule in 1989 that required all passenger carrying aircraft with more than 30 seats flying in U.S. airspace to be equipped with TCAS II by the end of 1991. This law was subsequently modified by Public Law 101-236 to extend the deadline for full equipage until the end of 1993. Based on the successful results of the in-

service evaluations, RTCA published Version 6.0 of the TCAS II MOPS (DO-185) in September 1989 and Version 6.0 units were put into full-time revenue service in the U.S. starting in June 1990.

As part of the mandated implementation, an extensive operational evaluation of TCAS, known as the TCAS Transition Program (TTP), was initiated in late 1991. In conjunction with the TTP in the U.S., EUROCONTROL conducted extensive evaluations of TCAS operations in Europe and the Japan Civil Aviation Bureau (JCAB) conducted similar assessments of TCAS II performance in Japanese and surrounding airspace. Other countries also conducted operational evaluations as the use of TCAS began to increase.

The system improvements suggested as a result of these TCAS II evaluations led to the development and release of Version 6.04a of the TCAS II MOPS (DO-185) published by RTCA in May 1993. The principal aim of this modification was the reduction of nuisance alerts which were occurring at low altitudes and during level-off maneuvers and the correction of a problem in the altitude crossing logic.

Version 7.0 Implementation

The results of the TTP evaluation of Version 6.04a indicated that the actual vertical displacement resulting from an RA response was often much greater than 300 feet, and TCAS was having an adverse affect on the controllers and the ATC system. This led to the development of Version 7.0 and numerous changes and enhancements to the collision avoidance algorithms, aural annunciations, RA displays, and pilot training programs to: (1) reduce the number of RAs issued, and (2) minimize altitude displacement while responding to an RA. Also included were: horizontal miss distance filtering to reduce the number of unnecessary RAs, more sophisticated multi-threat logic, changes to reduce nuisance repetitive TAs on RVSM routes in slow closure situations, changes to increase the

efficiency of the surveillance logic, and provision for sense reversals in TCAS-TCAS encounters.

The MOPS for Version 7.0 (DO-185A) was approved in December 1997 and Version 7.0 units began to be installed in the U.S. on a voluntary basis in late 1999.

Version 7.1 Implementation

Based on an extensive analysis of TCAS II Version 7.0 performance since 2000 performed primarily in Europe, additional changes to improve the RA logic were identified. In response to a near mid-air that occurred in Japan in 2001 and a mid-air that occurred at Ueberlingen, Germany, near the Swiss border in July 2002, a change was made to permit additional sense reversal RAs in order to address certain vertical chase geometries. It should be noted that in each of these cases, the pilots maneuvered opposite to the displayed RA. Separate from the Japan and Ueberlingen accidents, a review of other operational experience had shown that pilots occasionally maneuver in the opposite direction from that indicated by an "Adjust Vertical Speed, Adjust" (AVSA) RA. To mitigate the risk of pilots increasing their vertical rate in response to an AVSA RA, all AVSA RAs were replaced by "Level Off, Level Off" (LOLO) RAs.

Extensive validation of these changes was performed by the Europeans and the U.S. with the end result being publication of Version 7.1 of the MOPS (DO-185B) in June 2008. Version 7.1 units are expected to be operating by 2010-2011. It should be noted that Version 6.04a and 7.0 units are expected to remain operating for the foreseeable future where authorized.

Requirements for World-Wide Carriage

The U.S. was the first ICAO member State to mandate carriage of an airborne collision

avoidance system for passenger carrying aircraft operating in its airspace.

Because of this mandate, the number of long range aircraft being fitted with TCAS II and operating in European and Asian airspace continued to increase even though system carriage and operation was not mandatory in that airspace. As studies, operational experience, and evaluations continued to demonstrate the safety benefits of TCAS II, some non-U.S. airlines also equipped their short-haul fleets with TCAS.

In 1995, the EUROCONTROL Committee of Management approved an implementation policy and schedule for the mandatory carriage of TCAS II in Europe. The European Air Traffic Control Harmonization and Integration Program (EATCHIP) Project Board then ratified this policy. The approved policy requires that:

- From 1 January 2000, all civil fixed-wing turbine-powered aircraft having a maximum take-off mass exceeding 15,000 kg, or a maximum approved passenger seating configuration of more than 30, will be required to be equipped with TCAS II, Version 7.0;
- From 1 January 2005, all civil fixed-wing, turbine-powered aircraft having a maximum take-off mass exceeding 5,700 kg, or a maximum approved passenger seating configuration of more than 19, will be required to be equipped with TCAS II, Version 7.0.

Other countries, including Argentina, Australia, Chile, Egypt, India, and Japan, had also mandated carriage of TCAS II avionics on aircraft operating in their respective airspace.

The demonstrated safety benefits of the equipment, and the 1996 mid-air collision between a Saudia Boeing 747 and a Kazakhstan Ilyushin 76, resulted in an ICAO requirement for world-wide mandatory carriage of ACAS II on all aircraft, including cargo aircraft, beginning

in 2003. To guarantee the effectiveness of this mandate, ICAO has also mandated the carriage and use of pressure altitude reporting transponders, which are a prerequisite for the generation of RAs.

After the mid-air collision between a German Air Force Tupolev 154 and a U.S. Air Force C-141 transport aircraft, off Namibia in September 1997, urgent consideration was given to the need to equip military transport aircraft with TCAS. Several countries, including the U.S., initiated programs to equip tanker, transport and cargo aircraft within their military fleets with TCAS II Version 7.0.

In the U.S. effective Jan 1, 2005, for those aircraft required to carry TCAS II, Version 7.0 must be installed in all new installations. For installations of TCAS II made prior to Jan 1, 2005 under certain conditions, Version 6.04a can continue to be used.

RVSM Considerations

With the creation of Reduced Vertical Separation Minimum (RVSM) airspace, a minimum requirement for TCAS equipment was established. Specifically, in order to operate an aircraft with TCAS II in RVSM airspace, it must meet TSO-C119b (Version 7.0) or a later version. In the US, operations outside RVSM airspace with TCAS II can be conducted using Version 6.04a.

Standards and Guidance Material

The data obtained from FAA and industry sponsored studies, simulations, flight tests, and operational evaluations have enabled RTCA to publish the MOPS for TCAS II. The current version of the MOPS, DO-185B, describes the standards, requirements, and test procedures for TCAS Version 7.1. EUROCAE ED-143 is the equivalent document for ACAS II.

RTCA has also published MOPS for TCAS I, DO-197A, which defines the requirements and test procedures for TCAS I

equipment intended for use on airline aircraft operated in revenue service. The FAA has issued Technical Standard Order (TSO) C118a that defines the requirements for the approval of TCAS I equipment. A draft Advisory Circular outlining the certification requirements and the requirements for obtaining operational approval of the system has been prepared and is being used by the FAA's Aircraft Certification Offices (ACO) as the basis for approving TCAS I installations and operation.

For TCAS II, TSO C119c and Advisory Circular 20-151A have been published for use by FAA airworthiness authorities in certifying the installation of TCAS II on various classes of aircraft. Advisory Circular 120-55C defines the procedures for obtaining air carrier operational approval for the use of TCAS II. While FAA developed these documents, they have been used throughout the world by civil aviation authorities to approve the installation and use of TCAS, or as the basis for development of State-specific requirements and guidance.

ICAO Standards and Recommended Practices (SARPs) and Guidance Material for ACAS I and ACAS II have been published in Annex 10. The procedures for use of ACAS have been published in PANS-OPS Document 8168 and guidance to air traffic controllers, along with the phraseology for reporting TCAS RAs have been published in PANS-ATM, Document 4444. These documents provide international standardization for collision avoidance systems.

For the avionics, the Airlines Electronic Engineering Committee (AEEC) has published ARINC Characteristic 735A that defines the form, fit, and function of TCAS II units. The AEEC has also published ARINC Characteristic 718B for the Mode S transponder. *Note: A Mode S transponder is required as part of a TCAS II installation.*

TCAS II Components

A block diagram of TCAS II is shown in Figure 1. A TCAS II installation consists of the following major components.

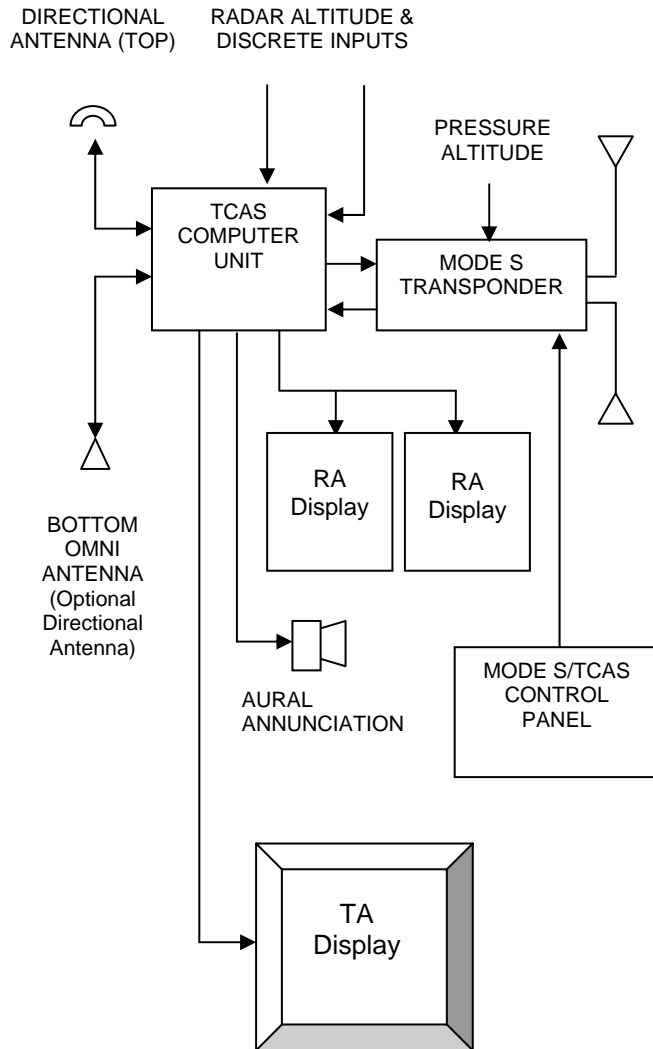

Figure 1. TCAS II Block Diagram

TCAS Computer Unit

The TCAS Computer Unit, or TCAS Processor performs airspace surveillance, intruder tracking, own aircraft altitude tracking, threat detection, RA maneuver

determination and selection, and generation of advisories. The TCAS Processor uses pressure altitude, radar altitude, and discrete aircraft status inputs from own aircraft to control the collision avoidance logic parameters that determine the protection volume around the TCAS. If a tracked aircraft selects an avoidance maneuver aircraft that will provide adequate vertical miss distance from the intruder while generally minimizing the perturbations to the existing flight path. If the threat aircraft is also equipped with TCAS II, the avoidance maneuver will be coordinated with the threat aircraft.

Mode S Transponder

A Mode S transponder is required to be installed and operational for TCAS II to be operational. If the Mode S transponder fails, the TCAS Performance Monitor will detect this failure and automatically place TCAS into Standby. The Mode S transponder performs the normal functions to support the ground-based ATC system and can work with either an ATCRBS or a Mode S ground sensor. The Mode S transponder is also used to provide air-to-air data exchange between TCAS-equipped aircraft so that coordinated, complementary RAs can be issued when required.

Mode S/TCAS Control Panel

A single control panel is provided to allow the flight crew to select and control all TCAS equipment including the TCAS Processor, the Mode S transponder, and in some cases, the TCAS displays. A typical control panel provides four (4) basic control positions:

- **Stand-by:** Power is applied to the TCAS Processor and the Mode S transponder, but TCAS does not issue any interrogations and the transponder will reply to only discrete interrogations. The transponder still transmits squitters. *Note: If the aircraft is on the ground and*

transmitting extended squitters, it is not required to transmit short (acquisition) squitters.

- **Transponder:** The Mode S transponder is fully operational and will reply to all appropriate ground and TCAS interrogations. TCAS remains in Stand-by.
- **TA Only:** The Mode S transponder is fully operational. TCAS will operate normally and issue the appropriate interrogations and perform all tracking functions. However, TCAS will only issue TAs; RAs will be inhibited.
- **Automatic or TA/RA:** The Mode S transponder is fully operational. TCAS will operate normally and issue the appropriate interrogations and perform all tracking functions. TCAS will issue TAs and RAs when appropriate.

As indicated in Figure 1, all TCAS control signals are routed through the Mode S transponder.

Antennas

The antennas used by TCAS II include a directional antenna that is mounted on the top of the aircraft and either an omnidirectional or a directional antenna mounted on the bottom of the aircraft. Most installations use the optional directional antenna on the bottom of the aircraft.

These antennas transmit interrogations on 1030 MHz at varying power levels in each of four 90° azimuth segments. The bottom mounted antenna transmits fewer interrogations and at a lower power than the top-mounted antenna. These antennas also receive transponder replies, at 1090 MHz, and send these replies to the TCAS Processor. The directional antennas permit the partitioning of replies to reduce synchronous garbling.

In addition to the two TCAS antennas, two antennas are also required for the Mode S

transponder. One antenna is mounted on the top of the aircraft while the other is mounted on the bottom. These antennas enable the Mode S transponder to receive interrogations at 1030 MHz and reply to the received interrogations at 1090 MHz. The use of the top or bottom mounted antenna is automatically selected to optimize signal strength and reduce multi-path interference. New transponder-TCAS integrated systems only require two antennas that are shared by the transponder and TCAS.

Because the TCAS unit and the transponder each generate transmission signals at the receiver frequency of the other, the TCAS and transponder are connected to an aircraft suppression bus that disables one when the other is transmitting.

Cockpit Presentation

The TCAS interface with the pilots is provided by two displays: (1) the traffic display and (2) the RA display. These two displays can be implemented in a number of ways, including incorporating both displays into a single, physical unit. Regardless of the implementation, the information provided is identical. The standards for both the traffic display and the RA display are defined in DO-185B and ED-143.

Traffic Display

The traffic display, which can be implemented on either a part-time or full-time basis, depicts the position of nearby traffic, relative to own aircraft. Displayed traffic information also includes traffic vertical speed indications, and Proximate, TA, and RA status. The primary purpose of the traffic display is to aid the flightcrew in the visual acquisition of transponder equipped aircraft. The secondary purpose of the traffic display is to provide the flightcrew with confidence in proper system operation, and to give them time to prepare to maneuver the aircraft in the event an RA is issued.

If implemented on a part-time basis, the display will automatically activate whenever a TA or an RA is issued. Current implementations include dedicated traffic displays; display of the traffic information on shared weather radar displays, map presentation displays, Engine Indication and Crew Alerting System (EICAS) displays, Navigation Display (ND), and other displays such as a Cockpit Display of Traffic Information (CDTI) used in conjunction with Automatic Dependent Surveillance - Broadcast (ADS-B) applications.

A majority of the traffic displays also provide the pilot with the capability to select multiple ranges and to select the altitude band for the traffic to be displayed. These capabilities allow the pilot to display traffic at longer ranges and with greater altitude separation while in cruise flight, while retaining the capability to select lower display ranges in terminal areas to reduce the amount of display clutter.

Traffic Display Symbology

Figure 2 shows the various traffic symbols used on the traffic display. Note that although some minor TCAS symbology differences may exist on TCAS/CDTI shared displays, the basic TA and RA shapes and colors remain unchanged.

Both color and shape are used to assist the pilot in interpreting the displayed information. Own-aircraft is depicted as a white or cyan airplane-like symbol. The location of own aircraft symbol on the display is dependent on the display implementation. Other aircraft are depicted using geometric symbols, depending on their threat status, as follows:

- An unfilled diamond, shown in either cyan or white, but not the same color as own-aircraft symbol, is used to depict "Other" non-threat traffic.
- A filled diamond, shown in either cyan or white, but not the same color as

own-aircraft symbol, is used to depict Proximate Traffic. Proximate Traffic is non-threat traffic that is within 6 nmi and ± 1200 ft from own aircraft.

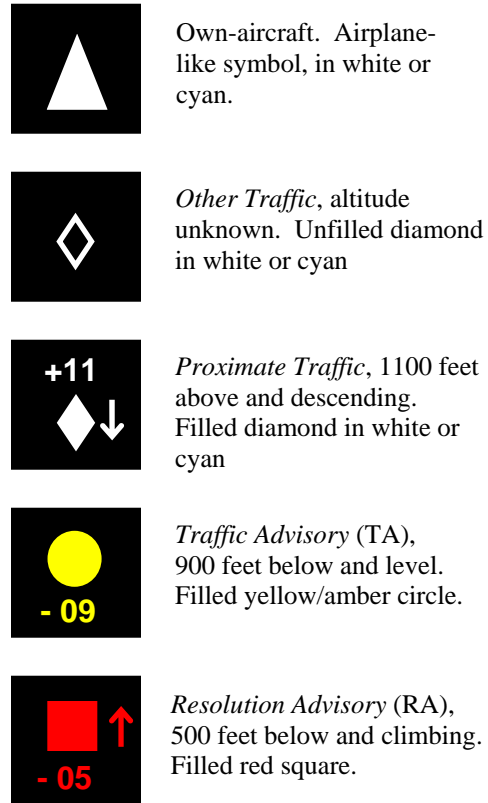

Figure 2. Standardized Symbology for Use on the Traffic Display

- A filled amber or yellow circle is used to display intruders that have caused a TA to be issued.
- A filled red square is used to display intruders that have caused an RA to be issued.

At a given time during operation, displayed traffic is likely to be Other. When a TA or RA occurs, TA, RA and Proximate traffic, within the selected display range, are required to be displayed. The display of Other traffic is recommended to assist the pilot in visually acquiring the intruder causing the RA or TA. Although Proximate

status of traffic can be derived by the pilot from the relative range and altitude, the symbol indication allows this state to be determined perceptually, from a quick glance.

Each symbol is displayed on the screen, according to its relative position to own aircraft. To aid the pilot in determining the range to a displayed aircraft, the traffic display provides range markings at one-half the selected scale and at the full scale. Additional range markings may be provided at closer ranges, e.g., 2 nmi, on some display implementations. The selected display range is also shown on the display. The range markings and range annunciation are displayed in the same color as own aircraft symbol unless the traffic display is integrated with an existing display that already provides range markings, e.g., a MAP display.

Relative altitude is displayed in hundreds of feet above the symbol if the intruder is above own aircraft and below the symbol if the intruder is below own aircraft. When the intruder is above own aircraft, the relative altitude information is preceded by a + sign. When the intruder is below own aircraft, a – sign precedes the relative altitude information. In some aircraft, the flight level of the intruder can be displayed instead of its relative altitude. The flight level is shown above the traffic symbol if the intruder is above own aircraft and below the traffic symbol if the intruder is below own aircraft. If the intruder is not reporting its altitude, no altitude information is shown for the traffic symbol. The altitude information is displayed in the same color as the aircraft symbol.

An arrow is displayed immediately to the right of a traffic symbol when the target aircraft is reporting its altitude and is climbing or descending at more than 500 fpm. An up arrow is used for a climbing aircraft; a down arrow is used for a descending aircraft. The arrow is displayed in the same color as the aircraft symbol.

When an aircraft causing a TA or RA is beyond the currently selected range of the traffic display, half TA or RA symbols will be displayed at the edge of the display at the proper relative bearing. In some implementations, a written message such as “TRAFFIC”, “TFC”, or “TCAS” is displayed on the traffic display if the intruder is beyond the selected display range, or if the selected display mode does not support the display of traffic. The half symbol or the written message will remain displayed until the traffic moves within the selected display range, the pilot increases the range on a variable range display to allow the intruder to be displayed, or the pilot selects a display mode that allows traffic to be displayed.

In some instances, TCAS may not have a reliable bearing for an intruder causing a TA or RA. Since bearing information is used for display purposes only, the lack of bearing information does not affect the ability of TCAS to issue TAs and RAs. When a “No-Bearing” TA or RA is issued, the threat level, as well as the range, relative altitude, and vertical rate of the intruder are written on the traffic display. This text is shown in red for an RA and in amber or yellow for a TA. For example, if an RA was issued against an intruder at a range of 4.5 nmi and with a relative altitude of +1200 feet and descending, the “No Bearing” indication on the traffic display would be:

RA 4.5 +12↓

Resolution Advisory (RA) Display

The RA display provides the pilot with information on the vertical speed or pitch angle to fly or avoid to resolve an encounter. The RA display is typically implemented on an instantaneous vertical speed indicator (IVSI), a vertical speed tape that is part of a Primary Flight Display (PFD), or using pitch cues displayed on the PFD. RA guidance has also been implemented on a Head-Up Display (HUD). The implementations using

the IVSI or a vertical speed tape utilize red and green lights or markings to indicate the vertical speeds to be avoided (red) and the desired vertical speed to be flown (green). An implementation using pitch cues uses a unique shape on the PFD to show the pitch angle to be flown or avoided to resolve an encounter. HUD implementations also use a unique shape to indicate the flight path to be flown or avoided to resolve an encounter.

In general, the round-dial IVSI implementation is used on the older "non-glass cockpit" aircraft. However, some operators have implemented this display in their "glass-cockpit" aircraft to provide a common display across their fleet types. Some IVSI implementations use mechanical instruments with a series of red and green LED's around the perimeter of the display, while other implementations use a LCD display that draw the red and green arcs at the appropriate locations. The LCD display implementations also have the capability to

provide both the traffic and RA display on a single instrument.

On "glass-cockpit" aircraft equipped with a PFD, some airframe manufacturers have implemented the RA display on the vertical speed tape; some have elected to provide pitch cues; and other implementations provide both pitch cues and a vertical speed tape.

The standards for the implementation of RA displays are provided in DO-185B. In addition to the implementations outlined above, DO-185B defines requirements for implementation of the RA display via the flight director. Two RA displays are required; one in the primary view of each pilot. Figure 3 shows an RA display implemented on a LCD that also provides traffic information. Figure 4 shows two possible implementations on the PFD.

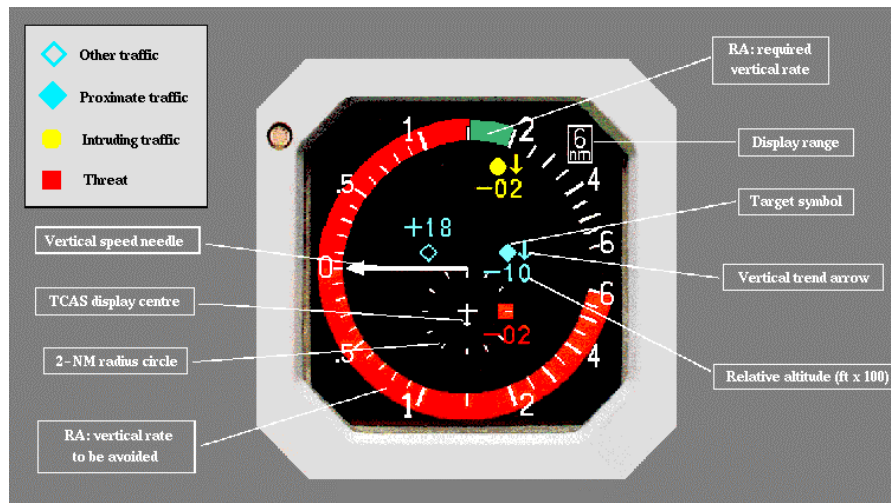
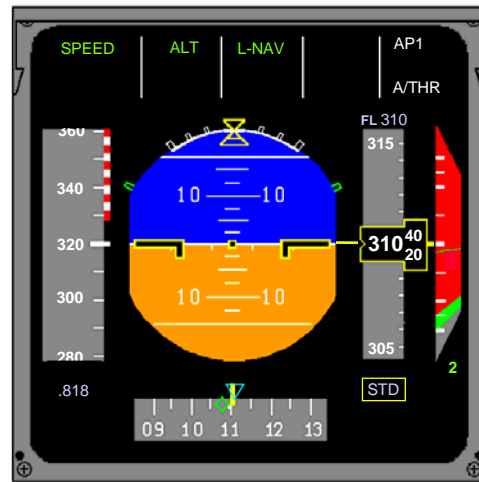
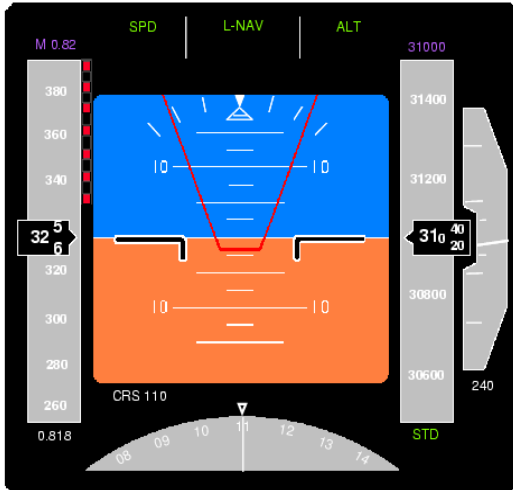

Figure 3. TCAS RA Display Implemented on an IVSI



Pitch Cue Implementation

Vertical Speed Tape Implementation

Figure 4. TCAS RA Displays Implemented on a PFD

Target Surveillance

TCAS, independent of any ground inputs, performs surveillance of nearby aircraft to provide information on the position and altitude of these aircraft so that the collision avoidance algorithms can perform their function. The TCAS surveillance function operates by issuing interrogations at 1030 MHz that transponders on nearby aircraft respond to at 1090 MHz. These replies are received and decoded by the surveillance portion of the TCAS software and the information is then provided to the collision avoidance algorithms.

TCAS has a requirement to provide reliable surveillance out to a range of 14 nmi and in traffic densities of up to 0.3 aircraft per square nautical mile. The surveillance function provides the range, altitude, and bearing of nearby aircraft to the collision avoidance function so that threat determinations can be made and so that the information displayed on the traffic display is accurate. The TCAS surveillance is compatible with both the ATCRBS and Mode S transponders. TCAS can simultaneously track up to 30 transponder-equipped aircraft within a nominal range of 30 nmi.

Because TCAS surveillance operates on the same frequencies as that used by the ground-based ATC radars, there is a requirement imposed on TCAS that it not interfere with the functions of the ATC radars. Several design features have been developed and implemented to allow TCAS to provide reliable surveillance without degrading the performance of the ATC radars.

Mode S Surveillance

Because of the selective address feature of the Mode S system, TCAS surveillance of Mode S equipped aircraft is relatively straightforward. TCAS listens for the spontaneous transmissions, or squitters, that

are generated once per second by the Mode S transponder. Among other information, the squitter contains the unique Mode S address of the sending aircraft. The Mode S address is known internationally as the ICAO 24-bit aircraft address.

Following the receipt and decoding of a squitter message, TCAS sends Mode S interrogations to the Mode S address contained in the squitter. These interrogations generally occur once per second. DO-185B requires interrogations to be transmitted at least once every five seconds. The Mode S transponder replies to these interrogations and the reply information is used by TCAS to determine range, bearing, and altitude of the Mode S aircraft.

To minimize interference with other aircraft and ATC on the 1030/1090 MHz channels, the rate at which a Mode S aircraft is interrogated by TCAS is dependent on the range and closure rate between the two aircraft. At extended ranges, a target is interrogated once every five seconds. As the target aircraft approaches the area where a TA may be required, the interrogation rate increases to once per second.

TCAS tracks the range and altitude of each Mode S target. These target reports are provided to the collision avoidance logic for use in the detection and advisory logic, and for presentation to the pilot on the traffic display. The relative bearing of the target is also provided to the collision avoidance logic for use in the Horizontal Miss Distance Filter and so that the target's position can be properly shown on the traffic display.

Mode C Surveillance

TCAS uses a modified Mode C interrogation known as the Mode C Only All Call to interrogate nearby Mode A/C transponders. The nominal interrogation rate for these transponders is once per second. Since TCAS does not use Mode A interrogations, the Mode A transponder codes of nearby aircraft are not known to TCAS.

Aircraft that are not equipped with an operating altitude encoder reply to these interrogations with no data contained in the altitude field of the reply. TCAS uses the framing pulses of the reply to initiate and maintain a range and bearing track on these targets. As with the Mode S tracks, these replies are passed to the collision avoidance logic for traffic advisory detection and for presentation on the traffic display.

The replies from aircraft that are capable of providing their Mode C altitude are tracked in range, altitude, and bearing. These target reports are passed to the collision avoidance logic for possible TA and RA selection and for presentation on the traffic display.

TCAS surveillance of Mode C targets is complicated by problems of synchronous and non-synchronous garbling, as well as reflections of signals from the ground (multipath). When a Mode C Only All Call interrogation is issued by TCAS, all Mode C transponders that detect the interrogation will reply. Because of the length of the reply message (20.3 microseconds), all Mode C equipped aircraft within a range difference of 1.7 nmi from the TCAS aircraft will generate replies that garble, or overlap each other, when received by TCAS. This is shown in Figure 5 and is called synchronous garble. Various techniques have been incorporated into TCAS to cope with this condition.

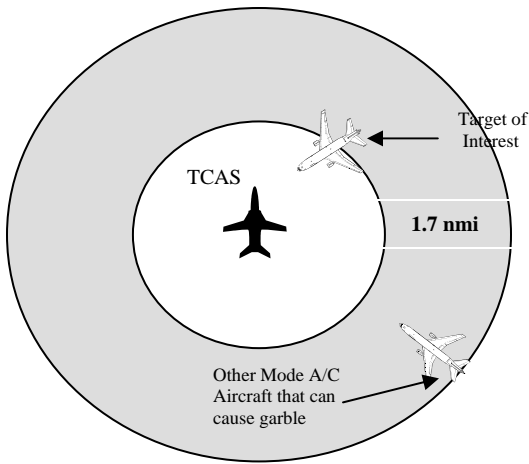

Figure 5. Synchronous Garble Area

Hardware degarblers can reliably decode up to three overlapping replies. In addition, the combined use of variable interrogation power levels and suppression pulses reduces the number of transponders that reply to a single interrogation. This technique, known as whisper-shout (WS), takes advantage of differences between the receiver sensitivity of transponders and the transponder antenna gains of target aircraft.

A low power level is used for the first interrogation step in a WS sequence. During the next WS step, a suppression pulse is first transmitted at a slightly lower level than the first interrogation. The suppression pulse is followed two microseconds later by an interrogation at a slightly higher power level. This action suppresses most of the transponders that had replied to the previous interrogation, but elicits replies from an additional group of transponders that did not reply to the previous interrogation. As shown in Figure 6, the WS procedure is followed progressively in 24 steps in the forward direction to separate the Mode C replies into several groups and thus reducing the possibility of garbling. WS sequences with fewer steps are used for the two sides and the aft direction. The WS sequence is transmitted once during each surveillance update period, which is nominally one second.

Another technique used to reduce synchronous garble is the use directional transmissions to further reduce the number of potential overlapping replies. This technique is shown in Figure 7. Slightly overlapping coverage must be provided in all directions to ensure 360-degree coverage. Synchronous garble is also reduced by the use of the Mode C Only All Call interrogation. This interrogation inhibits Mode S transponders from replying to a Mode C interrogation.

Non-synchronous garble is caused by the receipt of undesired transponder replies that were generated in response to interrogations from ground sensors or other TCAS interrogations. These so-called “fruit” replies are transitory so they are typically identified

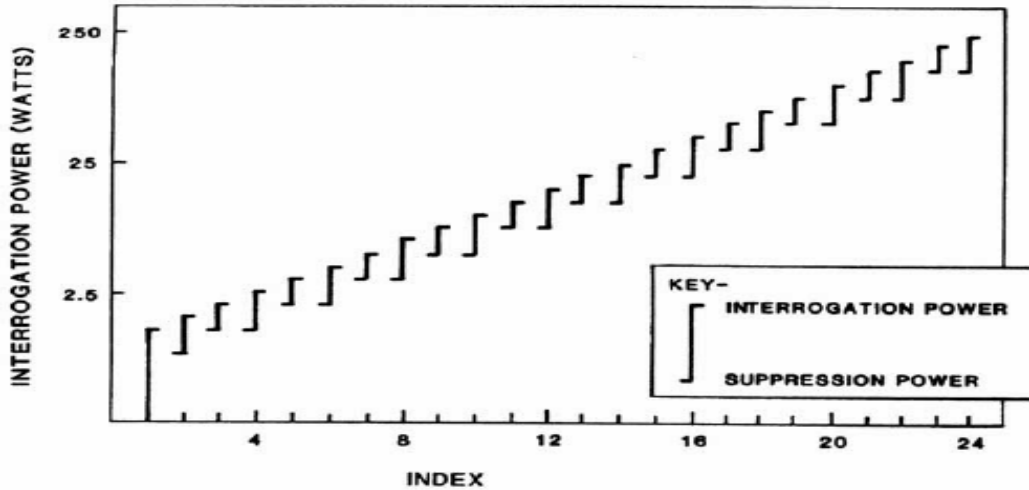

Figure 6 . Whisper-Shout Interrogation Sequence

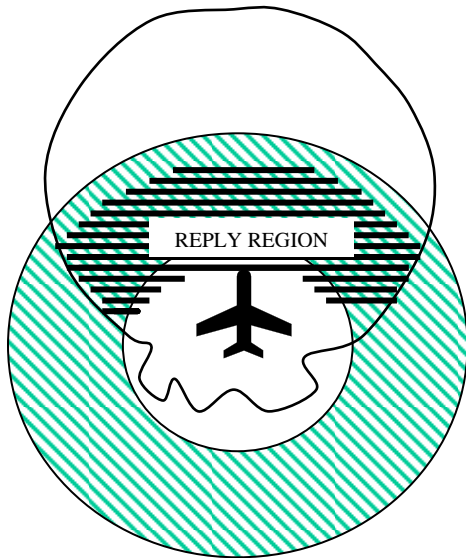

Figure 7. Directional Transmission

and discarded by correlation algorithms in the surveillance logic. Operational experience with TCAS has shown that the probability of initiating and maintaining a track based on fruit replies is extremely remote.

Avoiding the initiation of surveillance tracks based on multipath replies is another important consideration in the design of the TCAS surveillance. Multipath results in the detection of more than one reply to the same interrogation, generally of lower power, from

the same aircraft. It is caused by a reflected interrogation and usually occurs over flat terrain. To control multipath, the direct-path power level is used to raise the minimum triggering level (MTL) of the TCAS receiver enough to discriminate against the delayed and lower power reflections. This technique, referred to as Dynamic MTL (DMTL), is shown in Figure 8. As shown in Figure 8, the 4-pulse direct reply is above the DMTL level, while the delayed, lower-power multipath reply is below the DMTL threshold, and is thus rejected by TCAS.

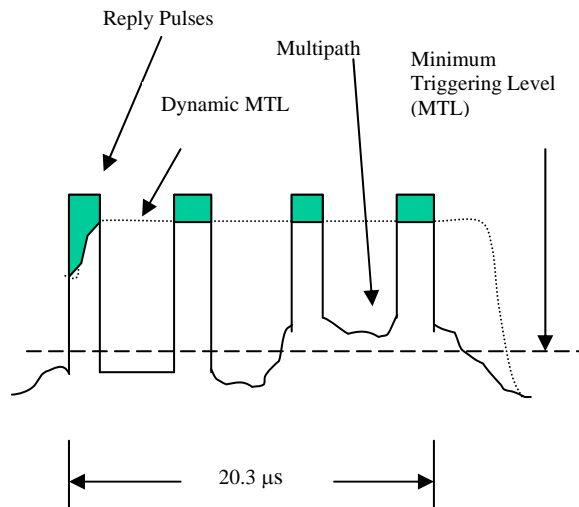

Figure 8. Dynamic Thresholding of ATCRBS Replies

Interference Limiting

Interference limiting is a necessary part of the surveillance function. To ensure that no transponder is suppressed by TCAS activity for more than two (2) percent of the time, and TCAS does not create an unacceptably high fruit rate for the ground-based ATC radars, multiple TCAS units within detection range of one another, i.e., approximately 30 nmi, are designed to limit their own transmissions under certain conditions. As the number of such TCAS units within this region increases, the interrogation rate and power allocation for each TCAS unit must decrease to prevent undesired interference with the ATC radars.

To achieve this, every TCAS unit counts the number of other TCAS units within detection range. This is accomplished by having each TCAS unit periodically (every 8-10 seconds) transmit a TCAS broadcast message that includes the Mode S address of the transmitting aircraft. Mode S transponders are designed to accept the broadcast messages without replying and pass the broadcast messages to their associated TCAS units. The messages are then used by the receiving TCAS' interference limiting algorithms to develop an estimate of the number of TCAS aircraft (NTA) within detection range. NTA is used by each TCAS to limit the interrogation rate and power as required.

While interference limiting has been an integral part of TCAS since its inception, initial operational experience with TCAS indicated that refinements were necessary in the surveillance design to meet the above-stated requirements. In Version 7.0, three key modifications were made to the interference limiting algorithms:

- (1) In addition to computing the *number* of nearby TCAS aircraft, each TCAS now also was required to estimate the *distribution* of those nearby TCAS aircraft. This allowed the algorithms to account for different distributions in

TCAS aircraft in the terminal (high-density) and en-route areas.

- (2) For TCAS aircraft flying above Flight Level (FL) 180, the interference limiting algorithms were simplified, allowing longer surveillance ranges for aircraft overflying high density traffic areas.
- (3) A maximum allowable interference limiting power reduction was introduced to ensure that the TCAS surveillance range is always adequate for collision avoidance.

Electromagnetic Compatibility

TCAS incorporates a number of design features to ensure that TCAS does not interfere with other radio services that operate in the 1030/1090 MHz frequency band. The design of the Mode S waveforms used by TCAS provide compatibility with the Mode A and Mode C interrogations of the ground based secondary surveillance radar system and the frequency spectrum of Mode S transmissions is controlled to protect adjacent distance measuring equipment (DME) channels.

The interference limiting features of TCAS also help to ensure electromagnetic compatibility with the ATC radar system. An extensive series of analyses, equipment tests, and computer simulations of the Version 7.0 and later surveillance software demonstrated that operationally significant interference will not occur between TCAS, secondary surveillance radar, and DME systems.

Hybrid Surveillance

Hybrid surveillance is a new feature which may be included as optional functionality in TCAS II units. Hybrid surveillance is a method to decrease the Mode S surveillance interrogations by an aircraft's TCAS unit. Specifically, TCAS units equipped with hybrid surveillance use passive surveillance instead of active surveillance to track intruders that meet validation criteria and are

not projected once to be near-term collision threats. With active surveillance, TCAS transmits interrogations to the intruder's transponder and the transponder replies provide range, bearing, and altitude for the intruder. With passive surveillance, position data provided by an onboard navigation source is broadcast from the intruder's Mode S transponder. The position data is typically based on GPS and received on own ship by the use of Mode S extended squitter, i.e. 1090 MHz ADS-B, also known as 1090ES. Standards for Hybrid Surveillance have been published in RTCA DO-300.

passive surveillance position is validated once per minute with a TCAS active interrogation. When the intruder is a near threat in altitude or range, but not both, it is tracked with passive surveillance, and the passive surveillance position is validated once every 10 seconds with an active TCAS interrogation. When the intruder is a near threat in altitude and range, it is tracked with active surveillance at a 1 Hz interrogation rate. The criteria for transitioning from passive to active surveillance were designed to ensure that all TCAS advisories will be based on active surveillance.

Once an intruder comes close to being a collision threat, it is tracked with active surveillance. Figure 9 illustrates how the system transitions from passive surveillance with validation to active surveillance as a function of the collision potential. When the intruder is far from being a threat, it is tracked with passive surveillance, and the

The intent of hybrid surveillance is to reduce the TCAS interrogation rate through the judicious use of the ADS-B data provided via the Mode S extended squitter without any degradation of the safety and effectiveness of the TCAS.

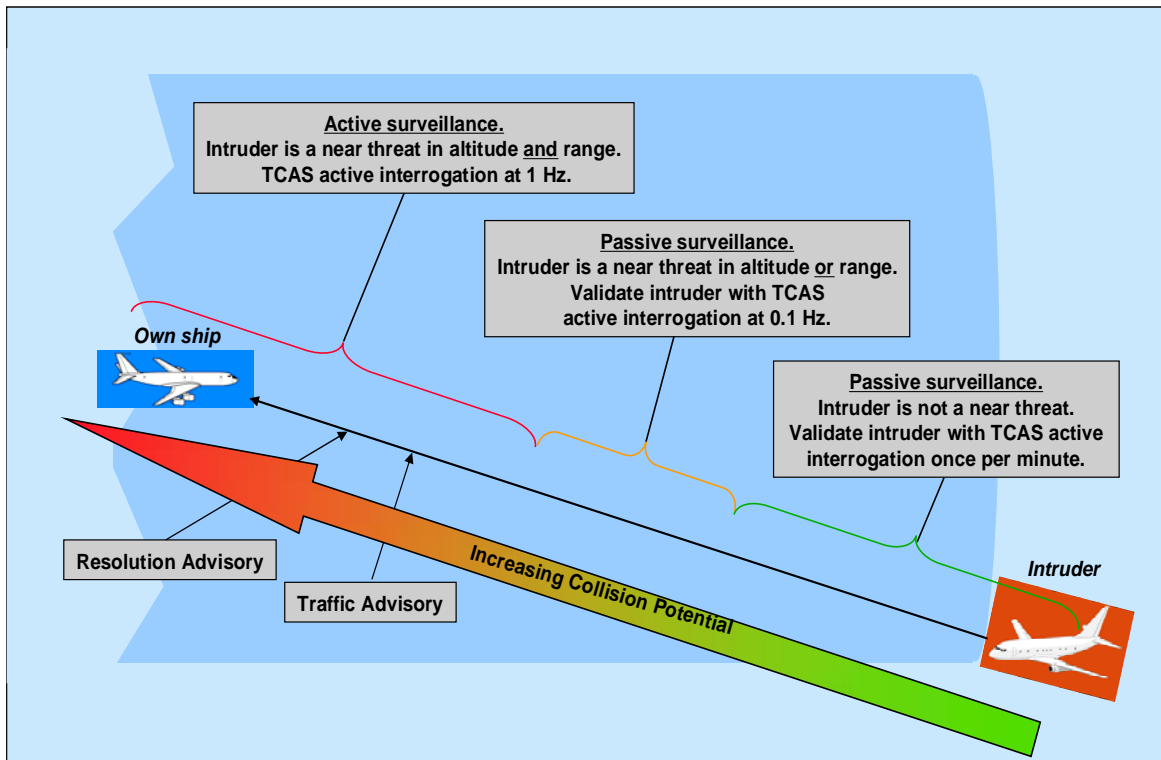

Figure 9. Transition from Passive to Active Surveillance

Collision Avoidance Concepts

Airborne collision avoidance is a complex problem. It has taken many years to develop an operationally acceptable solution and refinement of the system continues to maximize the compatibility between TCAS, ATC systems throughout the world, and existing cockpit procedures. The heart of collision avoidance is the collision avoidance system logic, or the CAS logic. To explain the operation of the CAS logic, the basic CAS concepts of sensitivity level, tau, and protected volume need to be understood.

Sensitivity Level

Effective CAS logic operation requires a trade-off between necessary protection and unnecessary advisories. This trade-off is accomplished by controlling the sensitivity level (SL), which controls the time or tau thresholds for TA and RA issuance, and therefore the dimensions of the protected airspace around each TCAS-equipped aircraft. The higher the SL, the larger the amount of protected airspace and the longer the alerting thresholds. However, as the amount of protected airspace increases, the incidence of unnecessary alerts has the potential to increase.

TCAS uses two means of determining the operating SL.

1. Pilot Selection. The TCAS Control Panel provides a means for the pilot to select three operating modes:
 - When the Control Panel switch is placed in the Standby Position, TCAS is operating in SL1. In SL1, TCAS does not transmit any interrogations. SL1 is normally selected only when the aircraft is on the ground or if TCAS has failed. The pilot selection of Standby on the

Control Panel is normally the only way that SL1 will be selected.

- When the pilot selects TA-ONLY on the control panel, TCAS is placed into SL2. While in SL2, TCAS performs all surveillance functions and will issue TAs as required. RAs are inhibited in SL2.
- When the pilot selects TA-RA or the equivalent mode on the control panel, the TCAS logic automatically selects the appropriate SL based on the altitude of own aircraft. Table 2 provides the altitude threshold at which TCAS automatically changes SL and the associated SL for that altitude band. In these SLs, TCAS performs all surveillance functions and will issue TAs and RAs as required

2. Ground Based Selection. Although the use of ground based control of SL has not been agreed to between pilots, controllers, and FAA and is not currently used in U.S. airspace, the capability for ground based control of SL is included in the TCAS design. This design feature allows the operating SL to be reduced from the ground by using a Mode S uplink message. The TCAS design allows the selection of any SL shown in Table 2 with the exception of SL1.

When the pilot has selected the TA-RA mode on the Control Panel, the operating SL is automatically selected via inputs from the aircraft's radar or pressure altimeter. SL2 will be selected when the TCAS aircraft is below 1,000 feet above ground level (AGL) (± 100 feet) as determined by the radar altimeter input. As previously stated, when in SL2, RAs are inhibited and only TAs will be issued.

In SL3 through SL7, RAs are enabled and issued at the times shown in Table 2. SL3 is set based on inputs from the radar altimeter, while the remaining SLs are set based on pressure altitude using inputs from own aircraft barometric altimeter.

Table 2. Sensitivity Level Definition and Alarm Thresholds

Own Altitude (feet)	SL	Tau (Seconds)		DMOD (nmi)		ZTHR (feet) Altitude Threshold		ALIM (feet)
		TA	RA	TA	RA	TA	RA	RA
< 1000 (AGL)	2	20	N/A	0.30	N/A	850	N/A	N/A
1000 - 2350 (AGL)	3	25	15	0.33	0.20	850	600	300
2350 – 5000	4	30	20	0.48	0.35	850	600	300
5000 – 10000	5	40	25	0.75	0.55	850	600	350
10000 – 20000	6	45	30	1.00	0.80	850	600	400
20000 – 42000	7	48	35	1.30	1.10	850	700	600
> 42000	7	48	35	1.30	1.10	1200	800	700

Tau

TCAS primarily uses time-to-go to CPA rather than distance to determine when a TA or an RA should be issued. The time to CPA is called the range tau and the time to co-altitude is called the vertical tau. Tau is an approximation of the time, in seconds, to CPA or to the aircraft being at the same altitude. The range tau is equal to the slant range (nmi) divided by the closing speed (knots) multiplied by 3600. The vertical tau is equal to the altitude separation (feet) divided by the vertical closing speed of the two aircraft (feet/minute) times 60.

TCAS II operation is based on the tau concept for all alerting functions. A TA or an RA is displayed only when both the range tau and vertical tau are less than certain threshold values that depend on sensitivity level. Table 2 provides the TA and RA tau thresholds used in each sensitivity level.

The boundary lines shown in Figure 10 indicate the combinations of range and range closure rate that would trigger a TA with a 40-second range tau and an RA with a 25-second range tau. These are the range taus used in SL5. Similar graphs can be generated for other sensitivity levels.

A problem with this simple definition of tau is that in encounters where the rate of closure is very low, such as those shown in Figure 11, an intruder aircraft can come very close in range without crossing the range tau

boundaries and thus, without causing a TA or an RA to be issued. To provide protection in these types of encounters, a modified definition of range tau is used that gives the boundaries shown in Figure 12. At larger ranges and higher closure rates these boundaries are essentially equal to those defined by the basic tau concept. However, at close ranges and at slower closure rates the modified tau boundaries converge to a non-zero range called DMOD. This modification allows TCAS to issue TAs and RAs at or before the fixed DMOD range threshold in these slow-closure-rate encounters. The value of DMOD varies with the different sensitivity levels and the values used to issue TAs and RAs are shown in Table 2.

There is a similar problem when the vertical closure rate of the TCAS and the intruder aircraft is low, or when they are close but diverging in altitude. To address that problem, TCAS uses a fixed altitude threshold, referred to as ZTHR, in conjunction with the vertical tau, to determine whether a TA or an RA should be issued. As with DMOD, ZTHR varies with sensitivity level and the TA and RA thresholds are shown in Table 2. Figure 13 shows the combinations of altitude separation and vertical closure rate that would trigger a TA with a 40-second vertical tau and an RA with a 25-second vertical tau, as appropriate for SL5. The ZTHR values are reflected in the level portion of the curve at low vertical closure rates.

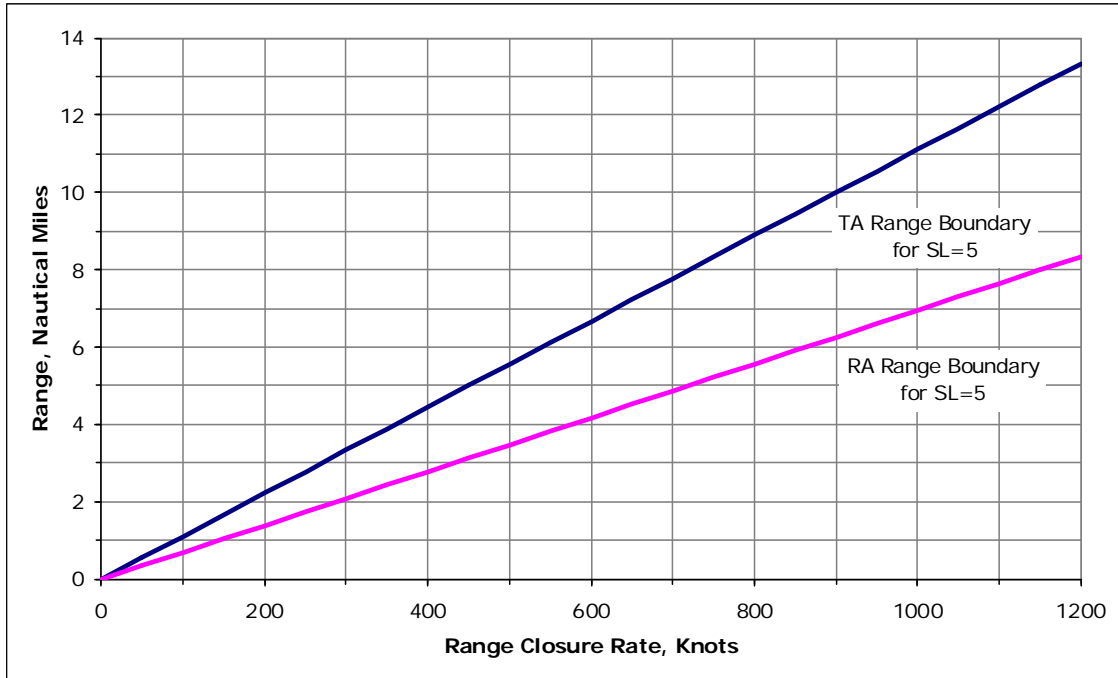

Figure 10. TA/RA Range Boundaries for SL5 using Unmodified Tau

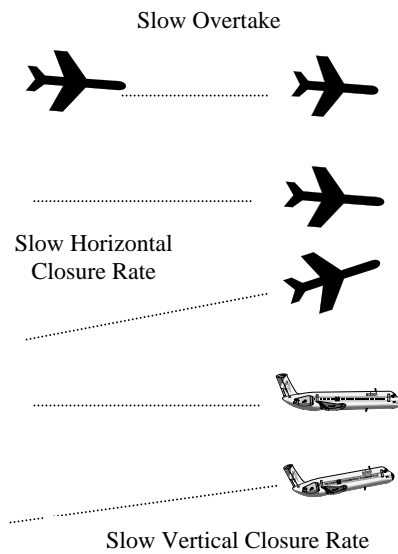

Figure 11. Need for Modified Tau

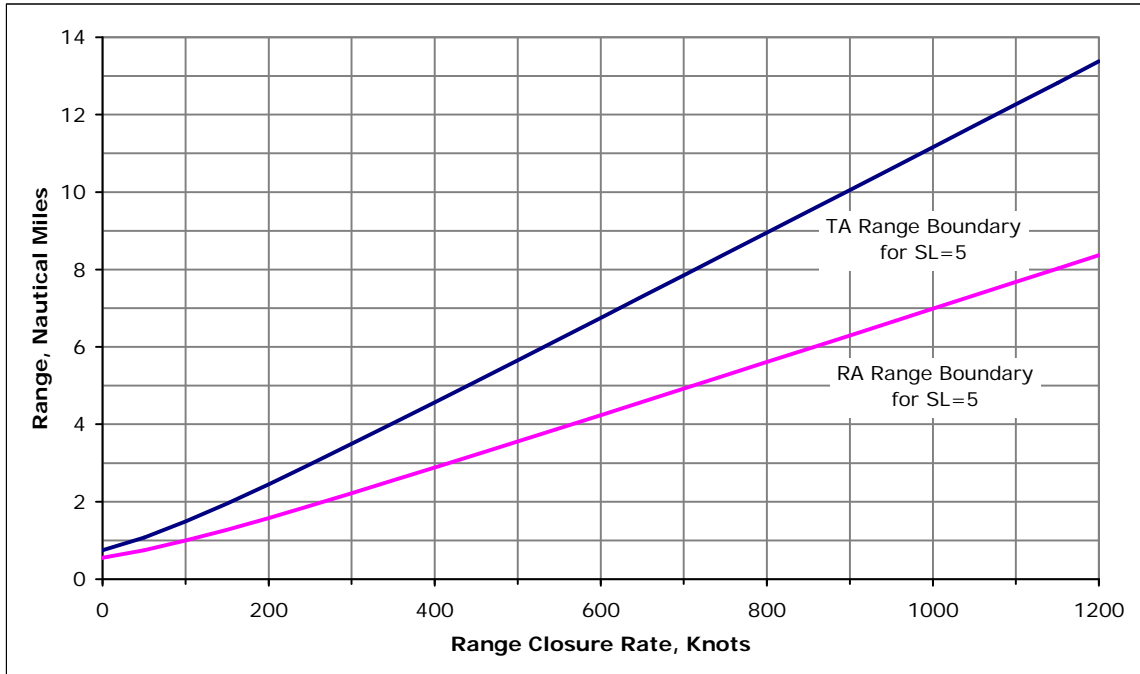

Figure 12. Modified TA/RA Range Tau Boundaries for SL5

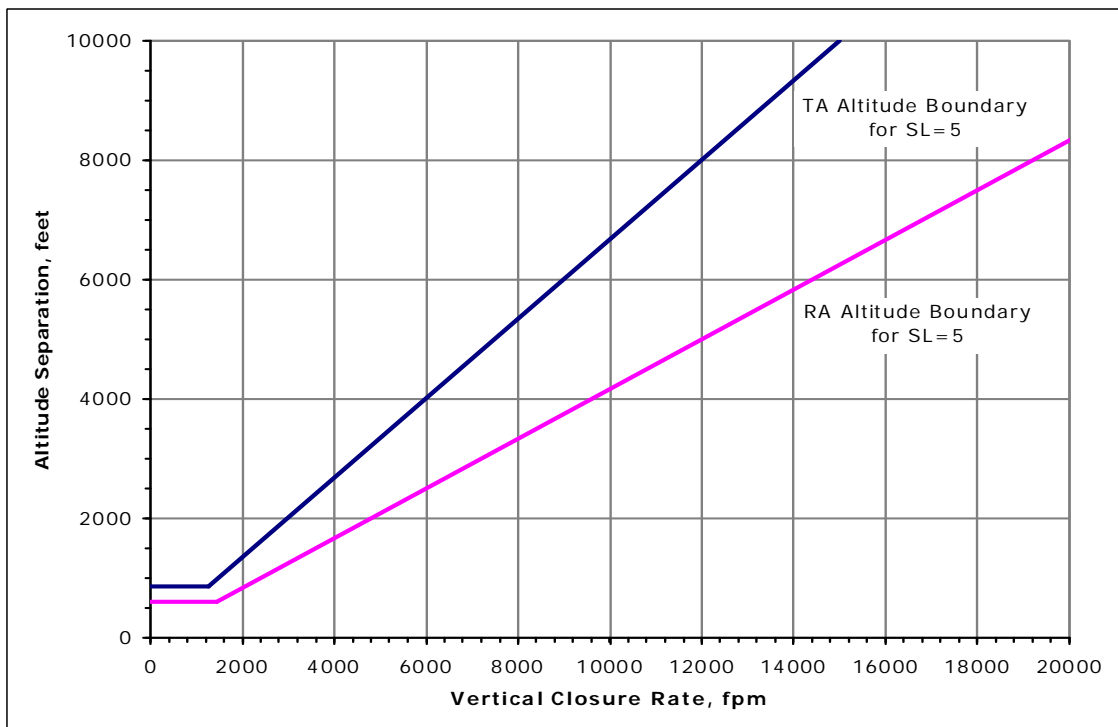

Figure 13. TA/RA Vertical Tau Boundaries for SL5

Protected Volume

A protected volume of airspace surrounds each TCAS-equipped aircraft. As shown in Figure 14, the tau and DMOD criteria described above shape the horizontal boundaries of this volume. The vertical tau and the fixed altitude thresholds determine the vertical dimensions of the protected volume.

The horizontal dimensions of the protected airspace are not based on distance, but on tau, plus an estimate of the protected horizontal miss distance. Thus, the size of the protected volume depends on the speed and heading of the aircraft involved in the encounter. The horizontal miss distance filter seeks to constrain the volume in order to exclude RAs for aircraft with sufficient lateral separation, and uses both range and bearing information to accomplish this.

TCAS II is designed to provide collision avoidance protection in the case of any two aircraft that are closing horizontally at any rate up to 1200 knots and vertically up to 10,000 feet per minute (fpm).

CAS Logic Functions

The logic functions employed by TCAS to perform its collision avoidance function are shown in Figure 15. The following descriptions of these functions are intended to provide a general level of understanding of these functions. The nature of providing an effective collision avoidance system results in the need to have numerous special conditions spread throughout the functions and these are dependent on encounter geometry, range and altitude thresholds, and

aircraft performance. These special conditions are beyond the scope of this document. A complete description of the CAS logic and additional details of its design and performance are contained in RTCA DO-185B, Section 2.2.5.

Tracking

Using the range, altitude (when available), and bearing of nearby aircraft that are provided to CAS by the Surveillance function, the CAS logic initiates and maintains a track on each aircraft. Successive range reports are used to compute range rate. Altitude information is used to estimate the vertical speed of each nearby altitude-reporting aircraft. The altitude tracking can use altitude that is quantized in either 25 or 100 foot increments. The CAS tracking function is designed to track aircraft with vertical rates of up to 10,000 fpm. The CAS logic uses the track information to determine the time to CPA and the altitude of each aircraft at CPA.

The CAS logic also uses the data from its own aircraft pressure altitude to determine the own aircraft altitude, vertical speed, and the relative altitude of each aircraft. The CAS logic uses the altitude source on own aircraft that provides the finest resolution. Own aircraft data can be provided as either fine altitude reports with quantization less than 10-foot increments, or as coarse altitude reports with quantization up to 100-foot increments. The outputs from the CAS tracking algorithm, i.e., range, range rate, relative altitude, and vertical rate are provided to the Traffic Advisory and Threat Detection logic to determine if a TA or an RA is needed.

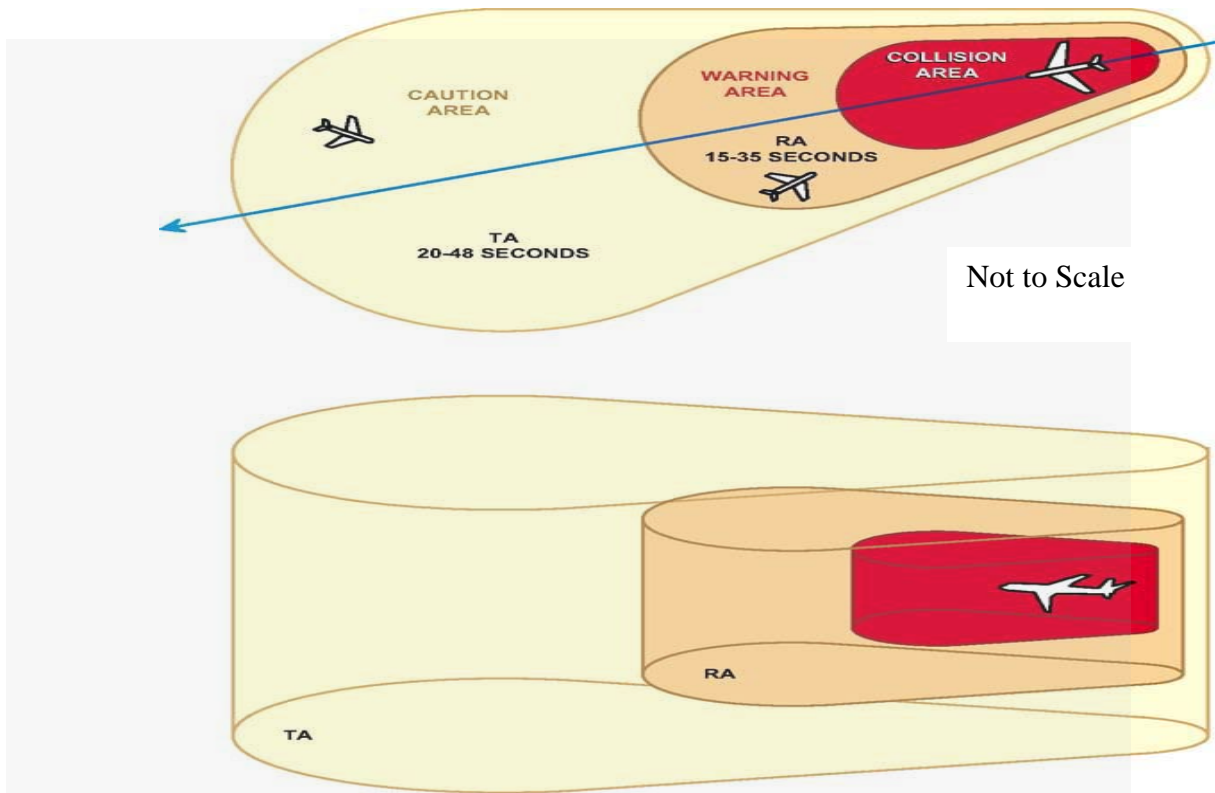

Figure 14. TCAS Protection Volume

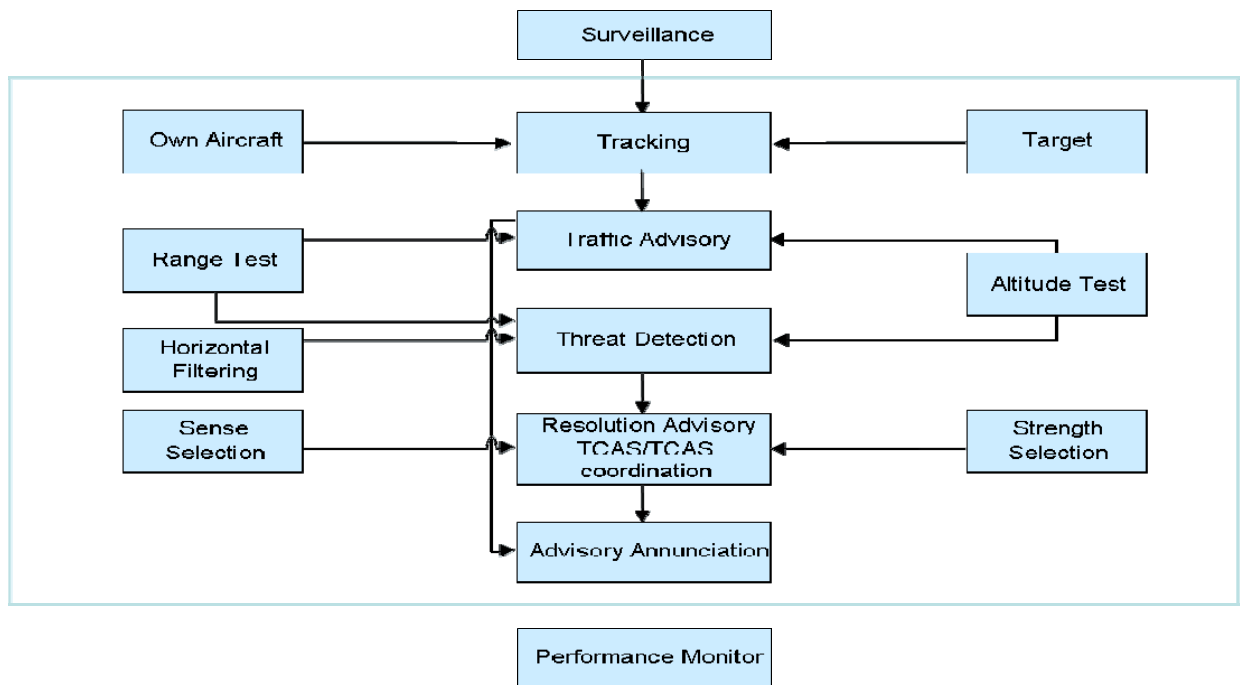

Figure 15. CAS Logic Functions

The CAS tracker also uses the difference between its own aircraft pressure altitude and radar altitude to estimate the approximate elevation of the ground above mean sea level. This ground estimation logic functions whenever own aircraft is below 1750 ft AGL. The ground level estimate is then subtracted from the pressure altitude received from each Mode C equipped nearby aircraft to determine the approximate altitude of each aircraft above the ground. If this difference is less than 360 feet, TCAS considers the reporting aircraft to be on the ground. If TCAS determines the intruder to be on the ground, it inhibits the generation of advisories against this aircraft. This methodology is shown graphically in Figure 16.

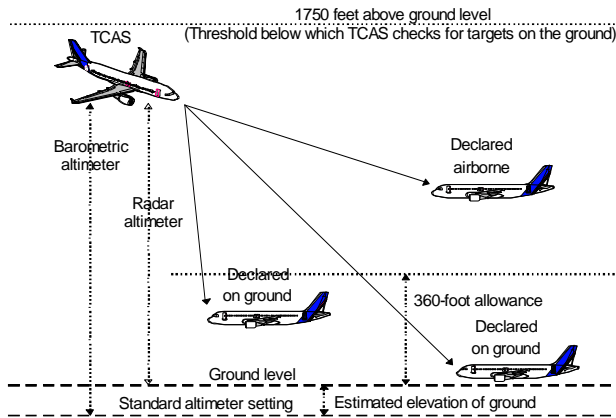

Figure 16. Mode C Target on Ground Determination

A Mode S equipped aircraft is considered to be on the ground if the on-the-ground status bit contained in either the squitter or transponder reply indicates the aircraft is on the ground.

Traffic Advisory

Using the tracks for nearby aircraft, range and altitude tests are performed for each altitude-reporting target. The range test is based on tau, and the TA tau must be less than the threshold shown in Table 2. In addition, the current or projected vertical separation at CPA must be within the TA

altitude threshold shown in Table 2 for a target to be declared an intruder. If the Traffic Advisory logic declares an aircraft to be an intruder, a TA will be issued against that aircraft.

A non-altitude reporting aircraft will be declared an intruder if the range test alone shows that the calculated tau is within the RA tau threshold associated with the current SL being used as shown in Table 2.

Version 7.0 included changes to ensure that a target's TA status is maintained in slow closure rate encounters by invoking more stringent requirements for removing a TA. These changes address problems reported in which multiple TAs were issued against the same target in parallel approach encounters and in RVSM airspace.

Threat Detection

Range and altitude tests are performed on each altitude-reporting intruder. If the RA tau and either the time to co-altitude or relative altitude criteria associated with the current SL are met, the intruder is declared a threat. Depending on the geometry of the encounter and the quality and age of the vertical track data, an RA may be delayed or not selected at all. RAs cannot be generated for non-altitude reporting intruders.

Version 7.0 included changes in the Threat Detection logic to improve the performance of this portion of the logic. These changes included:

- Declaring own aircraft to be on the ground when the input from the radar altimeter is valid and below 50 feet AGL. This precludes complete reliance on own aircraft's weight-on-wheels switch that has been shown to be unreliable in some aircraft.
- Preventing the SL from decreasing during a coordinated encounter to maintain the continuity of a displayed RA and thus, prevent multiple RAs

from being issued against the same intruder.

- Inhibiting threat declaration against intruder aircraft with vertical rates in excess of 10,000 fpm.
- Reducing alert thresholds to account for the reduction in vertical separation to 1000 feet above FL290 in RVSM airspace.
- Modifying the criteria used to reduce the frequency of “bump-up” or high vertical rate encounters. This modification allows a level aircraft to delay the issuance of an RA to allow additional time for detecting a level off maneuver by a climbing or descending aircraft.
- Introducing a horizontal miss distance (HMD) filter to reduce the number of RAs against intruder aircraft having a large horizontal separation at CPA. As part of the range test, the HMD filter can also terminate an RA prior to ALIM being obtained to minimize altitude displacement when the filter is confident that the horizontal separation at CPA will be large.

Resolution Advisory Selection

Initial Resolution Advisory Selection

When an intruder is declared a threat, a two step process is used to select the appropriate RA for the encounter geometry. The first step in the process is to select the RA sense, i.e., upward or downward. Based on the range and altitude tracks of the intruder, the CAS logic models the intruder’s flight path from its present position to CPA. The CAS logic then models upward and downward sense RAs for own aircraft, as shown in Figure 17, to determine which sense provides the most vertical separation at CPA.

Note: In modeling aircraft response to RAs, the expectation is the pilot will begin the initial 0.25 g acceleration maneuver within five seconds to an achieved rate of 1500

fpm. Pilot response with 0.35 g acceleration to an achieved rate of 2500 fpm is expected within 2.5 seconds for subsequent RAs.

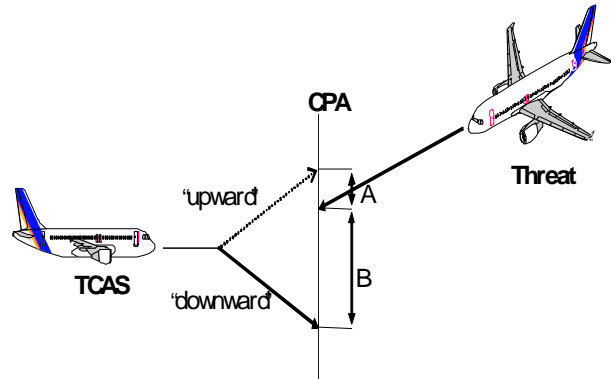

Figure 17. RA Sense Selection

In the encounter shown in Figure 17, the downward sense logic will be selected since it provides greater vertical separation. In encounters where either of the senses results in the TCAS aircraft crossing through the intruder’s altitude, TCAS is designed to select the non-altitude crossing sense if the non-crossing sense provides the desired vertical separation (ALIM) at CPA. If the non-altitude crossing sense provides at least ALIM feet of separation at CPA, this sense will be selected even if the altitude crossing sense provides greater separation. If ALIM cannot be obtained in the non-altitude crossing sense, an altitude crossing RA will be issued. Figure 18 shows an example of encounters in which the altitude crossing and non-altitude crossing RA senses are modeled and the non-crossing RA sense is selected.

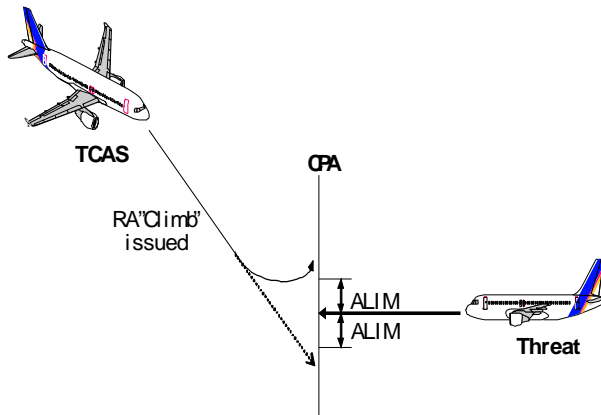

Figure 18. Selection of Non-Crossing RA Sense

Due to aircraft climb performance limitations at high altitude or in some flap and landing gear configurations, an aircraft installation may be configured to inhibit Climb or Increase Climb RAs under some conditions. These inhibit conditions can be provided via program pins in the TCAS connector or in real-time via an input from a Flight Management System (FMS). If these RAs are inhibited, the RA Selection Criteria will not consider them in the RA selection and will choose an alternative upward sense RA if the downward sense RA does not provide adequate vertical separation.

TCAS is designed to inhibit Increase Descent RAs below 1450 feet AGL; Descend RAs below 1100 feet AGL; and all RAs below 1000±100 feet AGL. If a Descend RA is being displayed as own aircraft descends through 1100 feet AGL, the RA will be modified to a Do Not Climb RA.

The second step in selecting an RA is to choose the strength of the advisory. The strength of an RA is the degree of restriction placed on the flight path by a vertical speed limit (negative) RA or the magnitude of the altitude rate wanted for positive RAs. TCAS is designed to select the RA strength that is the least disruptive to the existing flight path, while still providing ALIM feet of separation. An exception introduced in Version 7.1 is noted below.

RAs can be classified as positive (e.g., climb, descend) or negative (e.g., limit climb to 0 fpm, limit descend to 500 fpm). The term "Vertical Speed Limit" (VSL) is equivalent to "negative." RAs can also be classified as preventive or corrective, depending on whether own aircraft is, or is not, in conformance with the RA target altitude rate. Corrective RAs require a change in vertical speed; preventive RAs do not require a change in vertical speed.

A new feature was implemented in Version 7.0 to reduce the frequency of initial RAs that reverse the existing vertical rate of own aircraft. When two TCAS-equipped aircraft are converging vertically with opposite rates and are currently well separated in altitude, TCAS will first issue a vertical speed limit (VSL or Negative) RA to reinforce the pilots' likely intention to level off at adjacent flight levels. If no response to this initial RA is detected, or if either aircraft accelerates (vertically) toward the other aircraft, the initial RA will strengthen as required. This change was implemented to reduce the frequency of initial RAs that reversed the vertical rate of own aircraft (e.g., displayed a climb RA for a descending aircraft) because pilots did not follow a majority of these RAs, and those that were followed, were considered to be disruptive by controllers.

An exception to the "least disruptive RA" rule was introduced in Version 7.1. After TCAS Version 7.0 was introduced into the airspace, opposite initial responses to corrective VSL RAs (annunciated as "Adjust Vertical Speed, Adjust") were identified. The correct response to an AVSA RA is always a reduction in vertical speed. Several encounters were observed where the pilot increased vertical speed, causing further reduction in separation between own aircraft and the intruder. In Version 7.1, all corrective VSL RAs requiring non-zero vertical rates (500, 1000, or 2000 fpm) are changed to VSL 0 fpm RAs before being displayed to the pilot and are annunciated as "Level Off, Level Off". The VSL 0 fpm RA

is stronger than required, however this change was made to make the intention of the corrective VSL, i.e., a move toward level flight, unambiguously clear.

Table 3 provides a list of possible advisories that can be issued as the initial RA when only a single intruder is involved in the encounter. Table 3 is derived from DO-185B, Table 2-16. After the initial RA is selected, the CAS logic continuously monitors the vertical separation that will be provided at CPA and if necessary, the initial RA will be modified.

Strengthening Advisories

In some events, the intruder aircraft will maneuver vertically in a manner that thwarts the effectiveness of the issued RA. In these cases, the initial RA will be modified to either increase the strength or reverse the sense of the initial RA. Reversed sense RAs will be discussed separately. A VSL is strengthened by changing to a more restrictive VSL or to a positive Climb or Descend RA. A Climb or Descend RA is strengthened to an Increase Climb/Descent RA. An Increase Climb/Descent RA can

Table 3. Possible Initial RAs for Single Threat

RA Type	Upward Sense		Downward Sense	
	RA	Required Vertical Rate (fpm)	RA	Required Vertical Rate (fpm)
Positive (Corrective)	Climb	1500 to 2000	Descend	-1500 to -2000
Positive (Corrective)	Crossing Climb	1500 to 2000	Crossing Descend	-1500 to -2000
Positive (Corrective)	Crossing Maintain Climb	1500 to 4400	Crossing Maintain Descend	-1500 to -4400
Positive (Corrective)	Maintain Climb	1500 to 4400	Maintain Descend	-1500 to -4400
Negative (Corrective)	Reduce Descent	0	Reduce Climb	0
*Negative (Corrective)	Reduce Descent	> -500	Reduce Climb	< 500
*Negative (Corrective)	Reduce Descent	> -1000	Reduce Climb	< 1000
*Negative (Corrective)	Reduce Descent	> -2000	Reduce Climb	< 2000
Negative (Preventive)	Do Not Descend	> 0	Do Not Climb	< 0
Negative (Preventive)	Do Not Descend > 500 fpm	> -500	Do Not Climb > 500 fpm	< 500
Negative (Preventive)	Do Not Descend > 1000 fpm	> -1000	Do Not Climb > 1000 fpm	< 1000
Negative (Preventive)	Do Not Descend > 2000 fpm	> -2000	Do Not Climb > 2000 fpm	< 2000

* These Initial RAs cannot occur in Version 7.1

only be issued after a Climb/Descend RA has been displayed either as an initial RA, a strengthening of a negative RA, or a sense reversal RA.

Figure 19 depicts an encounter where it is necessary to increase the descent rate from the 1500 fpm required by the initial RA to 2500 fpm. This is an example of an Increase Descent RA.

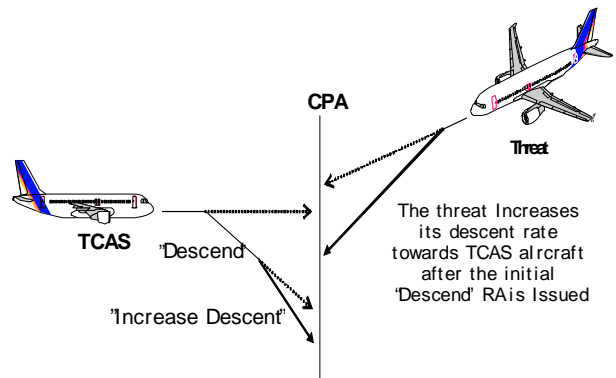

Figure 19. Increase Rate RA

Sense Reversals

Version 7.0 and later permit sense reversals in coordinated encounters. This sense reversal logic is very similar to that previously available in encounters with non-TCAS threats. Figure 20 depicts an encounter where an initial Climb RA requires reversal to a Descend RA after the intruder maneuvers.

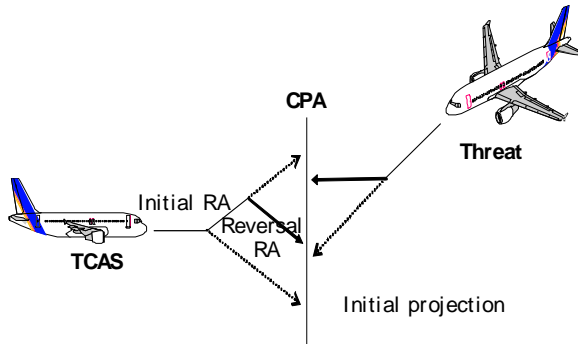

Figure 20. RA Reversal

After the introduction of Version 7.0 into the airspace, a weakness in the sense reversal logic was discovered. This issue was first observed in encounters with two TCAS equipped aircraft that were vertically close with both aircraft climbing or descending in the same vertical direction with one pilot following the TCAS RA and the other pilot not following the RA. Eventually this encounter geometry was determined to be problematic for encounters with a TCAS equipped aircraft and a non-TCAS threat. In Version 7.1, new reversal logic was added to address this situation. The new logic recognizes the “vertical chase with low vertical miss distance” geometry that can arise when either own aircraft or the threat maneuvers contrary to their RA in a coordinated encounter, or when an unequipped threat moves so as to thwart own aircraft’s RA.

Multiple-Threat Resolution Advisories

TCAS is designed to handle multi-threat encounters, i.e., those encounters in which more than one threat is active at the same

time. TCAS will attempt to resolve these types of encounters by selecting a single or composite RA that will provide adequate separation from each of the intruders. It is possible that the RA selected in such encounters may not provide ALIM separation from all intruders. An initial multi-threat RA can be any of the initial RAs shown in Table 3, or a combination of upward and downward sense negative RAs, e.g., Do Not Climb and Do Not Descend. Version 7.0 provided new capabilities to the multi-threat logic to allow this logic to utilize Increase Rate RAs and RA Reversals to better resolve encounters.

Weakening Advisories

During an RA, if the CAS logic determines that the response to a Positive RA has provided ALIM feet of vertical separation prior to CPA (i.e. the aircraft have become safely separated in altitude while not yet safely separated in range) before CPA, the initial RA will be weakened to either a Do Not Descend RA (after an initial Climb RA) or a Do Not Climb RA (after an initial Descend RA). This is done to minimize the displacement from the TCAS aircraft’s original altitude.

In Version 7.0 and later, after ALIM feet of separation has been achieved, the resulting Do Not Descend or Do Not Climb RA is designated as corrective. In Version 7.0, the RA is announced as “Adjust Vertical Speed, Adjust.” In Version 7.1, the RA is announced as “Level Off, Level Off.” (Version 6.04a keeps the original preventive designation, meaning that the RA is announced as “Monitor Vertical Speed.”)

In Version 7.0 and later, negative RAs will not be weakened and the initial RA will be retained until CPA unless it is necessary to strengthen the RA or reverse the RA sense.

After CPA is passed and the range between the TCAS aircraft and threat aircraft begins to increase, or if the horizontal miss distance filter is able to determine prior to CPA that

there will be sufficient horizontal miss distance, all RAs are cancelled.

TCAS/TCAS Coordination

In a TCAS/TCAS encounter, each aircraft transmits interrogations to the other via the Mode S link to ensure the selection of complementary RAs by the two aircraft. The coordination interrogations use the same 1030/1090 MHz channels used for surveillance interrogations and replies and are transmitted once per second by each aircraft for the duration of the RA. Coordination interrogations contain information about an aircraft's intended RA sense to resolve the encounter with the other TCAS-equipped intruder. The information in the coordination interrogation is expressed in the form of a complement. For example, when an aircraft selects an upward sense RA, it will transmit a coordination interrogation to the other aircraft that restricts that aircraft's RA selection to those in the downward sense. The strength of the downward sense RA would be determined by the threat aircraft based on the encounter geometry and the RA Selection logic.

The basic rule for sense selection in a TCAS/TCAS encounter is that each TCAS must check to see if it has received an intent message from the other aircraft before selecting an RA sense. If an intent message has been received, TCAS selects the opposite sense from that selected by the other aircraft and communicated via the coordination interrogation. (An exception to this occurs in Version 7.0 and later if the intruder has selected an altitude crossing sense and own TCAS satisfies a set of conditions that allows it to reverse that sense selection.) If TCAS has not received an intent message, the sense is selected based on the encounter geometry in the same manner as would be done if the intruder were not TCAS equipped.

In a majority of the TCAS/TCAS encounters, the two aircraft will declare the other aircraft to be a threat at slightly

different times. In these events, coordination proceeds in a straight-forward manner with the first aircraft declaring the other to be a threat, selecting its RA sense based on the encounter geometry, and transmitting its intent to the other aircraft. At a later time, the second aircraft will declare the other aircraft to be a threat, and having already received an intent from the first aircraft, will select a complementary RA sense. The complementary sense that is selected will then be transmitted to the other aircraft in a coordination interrogation.

Occasionally, the two aircraft declare each other as threats simultaneously, and therefore both aircraft will select their RA sense based on the encounter geometry. In these encounters, there is a chance that both aircraft will select the same sense. When this happens, the aircraft with the higher Mode S address will detect the selection of the same sense and will reverse its sense.

Version 7.0 added the capability for TCAS to issue RA reversals in coordinated encounters if the encounter geometry change after the initial RA is issued. The RA reversals in coordinated encounters are annunciated to the pilot in the same way as RA reversals against non-TCAS intruders. In a coordinated encounter, if the aircraft with the low Mode S address has Version 7.0 or later installed, it can reverse the sense of its initial RA and communicate this to the high Mode S address aircraft. The high Mode S address aircraft will then reverse its displayed RA. The aircraft with the high Mode S address can be equipped with any version of TCAS.

In a coordinated encounter, only one RA reversal based on changes in the encounter geometry can be issued.

Air/Ground Communications

Using the Mode S data link, TCAS can downlink RA reports to Mode S ground sensors. This information is provided in the Mode S transponder's 1090 MHz response

to an interrogation from a Mode S ground sensor requesting TCAS information.

For Version 7.0 and later, RA information is also provided automatically using the TCAS 1030 MHz transmitter. This RA Broadcast Message is an “uplink format” message, but it is intended for 1030 MHz receivers on the ground. This broadcast is provided when an RA is initially displayed to the flight crew and when the RA is updated, and is rebroadcast every eight (8) seconds in all directions.

For Version 7.0 and later, for 18 seconds after the end of the RA, both the RA Report and the RA Broadcast Message include an RA Terminator bit (RAT), indicating that the RA is no longer being displayed to the pilot.

Traffic Advisory (TA) Display

The functions of the traffic advisory display are to aid the flight crew in visually acquiring intruder aircraft; discriminating between intruder aircraft and other nearby aircraft; determining the horizontal position of nearby aircraft; and providing confidence in the performance of TCAS.

Traffic advisory displays have been implemented in a number of different ways and with varying levels of flexibility. The requirements for the various means of implementing the traffic displays are documented in RTCA DO-185B. An overview of the traffic display features and capabilities is provided earlier in this booklet.

Version 7.0 and later requirements inhibit the display of intruders with relative altitudes of more than ± 9900 feet if the pilot has selected the display of relative altitude. This display range is the maximum possible because only two digits are available to display the relative altitude.

Resolution Advisory (RA) Displays

The RA display is used by TCAS to advise the pilot how to maneuver, or not maneuver in some cases, to resolve the encounter as determined by the CAS logic. Examples for various RA display implementations are shown in Figure 3 and Figure 4. The requirements for RA displays are contained in RTCA DO-185B.

To accommodate physical limitations on some IVSI displays, Version 7.0 and later does not allow the display of any Maintain Rate RAs that call for vertical rates in excess of 4400 fpm. Because of this, the logic will model the minimum of the own aircraft’s vertical rate and 4400 fpm if a Maintain Rate RA is required, and will select the sense that provides the best separation, even if the selected sense is opposite the existing vertical speed.

Aural Annunciations

Whenever the collision avoidance algorithms issue a TA or an RA, a voice alert is issued to ensure that the pilots are aware of the information being displayed on the traffic and RA displays. These aural annunciations can be provided via a dedicated speaker installed in the cockpit or via the aircraft’s audio panels so that they are heard in the pilots’ headsets. Table 4 provides a listing of the aural annunciations that correspond to advisories used in all three TCAS versions. The TCAS advisory annunciations affected by Version 7.1 are highlighted. Aural annunciations are inhibited below 500 ± 100 feet AGL.

The TCAS aural annunciations are integrated with other environmental aural alerts available on the aircraft. The priority scheme established for these aural alerts gives windshear detection systems and ground proximity warning systems (GPWS) a higher annunciation priority than a TCAS

alert. TCAS aural annunciations will be inhibited during the time that a windshear or GPWS alert is active.

TCAS Advisory	Version 7.1 Annunciation	Version 7.0 Annunciation	6.04a Annunciation
Traffic Advisory	Traffic, Traffic		
Climb RA	Climb, Climb		Climb, Climb, Climb
Descend RA	Descend, Descend		Descend, Descend, Descend
Altitude Crossing Climb RA	Climb, Crossing Climb; Climb, Crossing Climb		
Altitude Crossing Descend RA	Descend, Crossing Descend; Descend, Crossing Descend		
Reduce Climb RA	Level Off, Level Off	Adjust Vertical Speed, Adjust	Reduce Climb, Reduce Climb
Reduce Descent RA	Level Off, Level Off	Adjust Vertical Speed, Adjust	Reduce Descent, Reduce Descent
RA Reversal to Climb RA	Climb, Climb NOW; Climb, Climb NOW		
RA Reversal to Descend RA	Descend, Descend NOW; Descend, Descend NOW		
Increase Climb RA	Increase Climb, Increase Climb		
Increase Descent RA	Increase Descent, Increase Descent		
Maintain Rate RA	Maintain Vertical Speed, Maintain		Monitor Vertical Speed
Altitude Crossing, Maintain Rate RA (Climb and Descend)	Maintain Vertical Speed, Crossing Maintain		Monitor Vertical Speed
Weakening of RA	Level Off, Level Off	Adjust Vertical Speed, Adjust	Monitor Vertical Speed
Preventive RA (no change in vertical speed required)	Monitor Vertical Speed		Monitor Vertical Speed, Monitor Vertical Speed
RA Removed	Clear of Conflict		

Table 4. TCAS Aural Annunciations

Performance Monitoring

TCAS is equipped with performance monitoring software that continuously and automatically monitors the health and performance of TCAS. The performance monitoring operates whenever power is applied to TCAS. In addition, the performance monitor includes a pilot-initiated test feature that includes expanded tests of TCAS displays and aural annunciations. The performance monitor supports expanded maintenance diagnostics that are available to maintenance personnel while the aircraft is on the ground.

The performance monitor validates many of the inputs received from other aircraft systems and validates the performance of the TCAS processor. Examples include own aircraft pressure altitude input and the connection of TCAS to the aircraft suppression bus.

When the performance monitor detects anomalous performance within TCAS or an invalid input from a required on-board system, the failure is annunciated to the pilot. If appropriate, all or a portion of the TCAS functions may be disabled or inhibited. If the performance monitor disables any TCAS capability, full operational capability will be restored once the detected failure is removed.

Requirements for Use

The information presented in this section is intended to provide a general understanding of the operational use of TCAS. FAA, ICAO, and other countries regulations contain the official guidance for TCAS use.

Regulations and Operational Guidance

Within the U.S., the guidance on the operational use of TCAS is contained in Advisory Circular (AC) 120-55C. This AC provides guidelines for developing flight crew training programs, procedures for responding to an RA, a list of good operating practices, sample forms for providing reports on the performance of TCAS, and suggested phraseology to be used when advising controllers of an RA event.

Information similar to that contained in AC 120-55C is included in ICAO Annexes and other documentation. Individual countries have used the information contained in the ICAO documentation to develop and promulgate their own requirements and procedures. There are differences in procedures from State to State and these differences can be found in a State's Aeronautical Information Publication (AIP).

Controller's Responsibilities

The guidance for controllers regarding TCAS operation for controllers is contained in the ATC Controllers Handbook (Order 7110.65) and in various policy letters issued by FAA Headquarters. The controller's responsibilities during a TCAS RA stated in FAA Order 7110.65 are given below.

If an aircraft under your control jurisdiction informs you that it is responding to a TCAS RA, do not issue control instructions that are contrary to the RA the crew has advised you that they are executing. Provide safety alerts regarding terrain or obstructions and traffic advisories for the aircraft responding to the RA and all other aircraft under your control jurisdiction, as appropriate.

Unless advised by other aircraft that they are

also responding to a TCAS RA, do not assume that the other aircraft in proximity of the responding aircraft are involved in the RA maneuver or are aware of the responding aircraft's intended maneuvers. Continue to provide control instructions, safety alerts, and traffic advisories as appropriate to such aircraft.

Once the responding aircraft has begun a maneuver in response to an RA, the controller is not responsible for providing standard separation between the aircraft that is responding to an RA and any other aircraft, airspace, terrain, or obstructions. Responsibility for standard separation resumes when one of the following conditions is met:

1. The responding aircraft has returned to its assigned altitude.
2. The flight crew informs you that the TCAS maneuver is completed and you observe that standard separation has been established.
3. The responding aircraft has executed an alternate clearance and you observe that standard separation has been re-established.

FAA order 7110.65 also references AC 120-55 to provide information on the suggested phraseology to be used by pilots to notify the controller about a TCAS event. The suggested phraseology is discussed in the following section on pilot's responsibilities.

Pilot's Responsibilities

In general terms, the following procedures and practices have been developed regarding the pilot's responsibilities and actions while using TCAS. These procedures and practices are extracted from AC 120-55C. Respond to TAs by attempting to establish visual contact with the intruder and other aircraft that may be in the vicinity. Coordinate to the degree possible with other crew members to assist in searching for

traffic. **Do not deviate from an assigned clearance based only on "TA" information.** For any traffic that is acquired visually, continue to maintain or attain safe separation in accordance with current Federal Aviation Regulations (FAR) and good operating practices.

When an RA occurs, the pilot flying should respond immediately by direct attention to RA displays and maneuver as indicated, unless doing so would jeopardize the safe operation of the flight, or unless the flight crew can assure separation with the help of definitive visual acquisition of the aircraft causing the RA. By not responding to an RA, the flight crew effectively takes responsibility for achieving safe separation.

To satisfy RAs, disconnect the autopilot and maneuver using prompt, positive control inputs in the direction and with the magnitude TCAS advises. To achieve the required vertical rate (normally 1,500 fpm for a Climb or Descend RA), first adjust the aircraft's pitch using the suggested guidelines shown in Table 5.

Speed	Pitch Adjustment
.80 Mach	2 degrees
250 Knots Indicated Airspeed (KIAS) Below 10,000 feet	4 degrees
Below 200 KIAS	5 to 7 degrees

Table 5. Suggested Pitch Adjustment Required to Comply with a TCAS Climb or Descend RA

Then refer to the vertical speed indicator and make necessary pitch adjustments to place the vertical speed indicator in the green arc of the RA display. On aircraft with pitch guidance TCAS RA displays, follow the RA pitch command for initial, increase, and weakening RAs.

Excursions from assigned altitude, when responding to an RA, typically should be no more than 300 to 500 feet to satisfy the conflict. Vertical speed responses should be made to avoid red arcs or outlined pitch

avoidance areas, and, if applicable, to accurately fly to the green arc or outlined pitch guidance area. **During an RA, do not maneuver contrary to the RA. In the event that the RA direction conflicts with an ATC clearance or instruction, follow the RA.**

TCAS expects the initial vertical speed response to a “climb” or “descend” maneuver advisory using 1/4g acceleration within 5 seconds after issuance of the advisory. Initial vertical speed response to an increase or reversal RA is expected by TCAS using 1/3g acceleration within 2 1/2 seconds after issuance of the advisory. Again, avoid red arcs or outlined pitch avoidance areas and fly to the green arc or outlined pitch guidance area. .

If an initial corrective RA is downgraded or weakened (for example, a Climb RA downgrades to a Do Not Descend RA), pilots should respond to the weakening RA and adjust the aircraft's vertical speed accordingly but still keep the needle or pitch guidance symbol out of the red arc or outlined pitch avoidance area. Pilots are reminded that attention to the RA display and prompt reaction to the weakened RA will minimize altitude excursions and potential disruptions to ATC. This will also allow for proper TCAS/TCAS resolution of encounters and reduce the probability of additional RAs against the intruder or other traffic. For TCAS Version 7.0 and later, a "green arc on weakening" is provided to guide the proper response.

In some instances it may not be possible to respond to a TCAS RA and continue to satisfy a clearance at the same time. Even if a TCAS RA maneuver is inconsistent with the current clearance, respond appropriately to the RA. Since TCAS tracks all transponder-equipped aircraft in the vicinity, responding to an RA for an intruder assures a safe avoidance maneuver from that intruder and from other transponder-equipped aircraft.

If a TCAS RA response requires deviation from an ATC clearance, expeditiously return to the current ATC clearance when the traffic conflict is resolved and the TCAS message “Clear of Conflict” is heard, or follow any subsequent change to clearance as advised by ATC. In responding to a TCAS RA that directs a deviation from assigned altitude, communicate with ATC as soon as practicable after responding to the RA. When the RA is removed, the flight crew should advise ATC that they are returning to their previously assigned clearance or should acknowledge any amended clearance issued.

Unless approved by the Administrator, pilots are expected to operate TCAS while in-flight in all airspace, including oceanic, international, and foreign airspace.

TCAS does not alter or diminish the pilot's basic authority and responsibility to ensure safe flight. Since TCAS does not detect aircraft that are not transponder equipped or aircraft with a transponder failure, TCAS alone does not ensure safe separation in every case. Further, TCAS RAs may, in some cases, conflict with flight path requirements due to terrain, such as an obstacle-limited climb segment or an approach towards rising terrain. Since many approved instrument procedures and IFR clearances are predicated on avoiding high terrain or obstacles, it is particularly important that pilots maintain situational awareness and continue to use good judgment in following TCAS RAs. Maintain frequent outside visual scan, "see and avoid" vigilance, and continue to communicate as needed and as appropriate with ATC.

The pilot is to inform the controller about an RA deviation as soon as possible. The phraseology to be used by pilots is shown in Table 6.

Table 6. Recommended Phraseology for Reporting RAs Within U.S. Airspace

Situation	Phraseology
Responding to an RA	“TCAS Climb” or “TCAS Descend”
Initial RA report issued after RA is completed	“TCAS Climb (or descent), returning to [assigned clearance]”
Initial RA report issued after returning to assigned clearance	“TCAS Climb (or descent) completed, [assigned clearance] resumed”
Unable to follow a newly issued clearance because of an RA	“Unable to comply, TCAS resolution advisory”
Controller acknowledgement of any TCAS report	No specific phraseology is defined

The phraseology shown in Table 6 is suggested and should contain: (1) name of the ATC facility, (2) aircraft identification (ID), and (3) that the aircraft is responding to a TCAS RA. When a flight crew receives a TCAS RA to either climb or descend from their assigned altitude, or the RA otherwise affects their ATC clearance, or their pending maneuver or maneuver in progress, the crew should inform ATC when beginning the excursion from clearance or as soon as workload allows in the following manner: “XYZ Center, (Aircraft ID), TCAS Climb/Descent”.

Following such a communication, the designated air traffic facility is not required to provide approved standard separation to the TCAS maneuvering aircraft until the TCAS encounter is cleared and standard ATC separation is achieved. If workload permits, traffic information may be provided by the controller in accordance with FAA Order 7110.65. When the RA is removed, the flight crew should advise ATC that they are returning to their previously assigned clearance or subsequent amended clearance. When the deviating aircraft has renegotiated

its clearance with ATC, the designated air traffic facility is expected to resume providing appropriate separation services in accordance with FAA Order 7110.65.

Note: Communication is not required if the pilot is able to satisfy the RA guidance and maintain the appropriate ATC clearance.

A significant number of unnecessary RAs are generated when aircraft converge with high vertical rates. Guidance in the U.S. Airman’s Information Manual (AIM), and recently adopted by some international agencies, direct that the rate of climb or descent be reduced during the last 1000 feet of climb or descent.

The AIM, for example says “attempt to descend or climb at a rate of between 500 and 1,500 fpm until the assigned altitude is reached” whereas EUROCONTROL recommends reducing the rate to 1000 fpm. Modern aircraft auto flight systems produce higher vertical rates during this phase of flight in order to achieve maximum fuel efficiency. Many operators of these systems are reluctant to direct their crews to interfere with the auto flight guidance during the last 1000 feet of climb or descent, either because of reduced fuel efficiency or concern that the assigned altitude might not be captured. This policy may be satisfactory for most climbs and descents, however when an aircraft is climbing or descending to an assigned altitude where there is traffic at an adjacent altitude, an unnecessary RA may be generated.

While some operators do not address this issue in their Airplane Flight Manuals (AFMs) or Training Programs some do address the issue during Line Operations Training with the result that some pilots follow the recommended guidance while most do not. Operational experience shows that good results are obtained by allowing the auto flight system to fly the last 1000 feet of climb or descent, except when there is known traffic at the adjacent altitude. At this time the pilot should reduce the vertical

speed by use of the proper auto flight mode control panel input, while taking care not to disarm the altitude capture mode. Many of the unnecessary RAs being generated would be eliminated by this procedure.

Training Programs

Many of the operational issues identified during the operation of TCAS can be traced to misunderstandings regarding the operation of TCAS, its capabilities, and its limitations. For these reasons, it is essential that all pilots operating the system be trained in how to use the system and that all controllers receive training on how TCAS operates, how pilots are expected to use the systems, and the potential interactions between TCAS and the ATC system.

FAA and industry have worked together to develop and refine training guidelines for both pilots and controllers. AC 120-55C contains guidance for the development and implementation of pilot training programs. While this AC is not directly applicable to operators that are governed by Part 91 and Part 135 of the Federal Aviation Regulations, the training guidelines contained in the AC should be followed by these operators. *Note: Part 142 Training Centers should be cognizant of the training guidelines contained in AC 120-55C when developing and providing TCAS training.*

FAA has also developed and distributed a controller training program to all of its ATC facilities.

ICAO has published guidelines for both pilot and controller training programs in the ACAS Manual and this information is available to all ICAO member States.

Controller Training Programs

Controllers need to be aware of the presence, capabilities, and limitations of TCAS while performing their responsibilities. The controller training

should be similar to the classroom training provided to pilots and should include scenarios that demonstrate both the positive and negative impacts of pilots responding to RAs in the ATC environment

Version 7.1 Effects on Controller Training. Version 7.1 logic is expected to have some effect on controllers. Controllers will see an increase in unexpected level-offs during climbs and descents due to pilots responding to LOLO RAs. Many AVSA RAs that are not noticed by controllers with Version 7.0 logic will now be visible to controllers as flight crews respond to LOLO RAs. This change in Version 7.1 logic must be taken into consideration and controller training programs need to be modified to educate controllers on this change to the TCAS logic.

Pilot Training Programs

Experience has shown that it is essential that crews operating TCAS-equipped aircraft complete an approved pilot-training course. The proper use of TCAS II by pilots is required to ensure the proper operation of TCAS in the air traffic control environment and the realization of the expected improvements in flight safety. Pilot training should include two complementary parts as defined below.

Theory. Pilots should have an understanding of how TCAS works. This includes an understanding of the alert thresholds, expected response to TAs and RAs, proper use of TCAS-displayed information, phraseology for reporting RAs, and system limitations. This training is generally accomplished in a classroom environment.

Simulator Practice. The response to an RA requires prompt and appropriate responses from the flight crews involved. Therefore, it is necessary to include RA events in routine flight simulator training exercises so that pilots can experience the circumstances surrounding an RA in a realistic

environment. When the inclusion of TCAS into simulator training programs is not possible, FAA has approved the use of other interactive training devices to supplement the classroom training. Until fairly recently, most TCAS operators obtained FAA approval for these devices because of the lack of good simulator TCAS software programs. Older programs required the expenditure of valuable simulator time for setting up the TCAS encounter and there was a limited menu of RA types that could be generated. Newer simulators have improved TCAS programs available and some operators present TCAS training in these simulators for initial and recurrent TCAS training. Since some pilots see few RAs in line operations and better TCAS simulator programs are now available, operators should make every effort to make simulator training the standard for TCAS initial and recurrent training. When training is conducted in simulators, a variety of encounter types should be used, not just Climb and Descend RAs.

Version 7.1 Effects On Pilot Training.

The new logic in Version 7.1 will require a minimum amount of additional training. The only significant change for pilots is the change in one aural annunciation from "Adjust Vertical Speed, Adjust" to "Level Off, Level Off". This and other differences in Version 7.1 that are transparent to the pilot can be discussed in Operational Bulletins or similar material.

Operational Experience

Performance Monitoring Programs

Since TCAS II was first introduced, a number of countries have established programs to monitor the performance of TCAS II. These programs are used to facilitate evaluation of the safety improvement it provides and its operational

acceptability to pilots and controllers. The two largest programs are those that have been taking place in the U.S. and European airspace. In the U.S., the TCAS II Transition Program (TTP) was established by FAA following the implementation of the first production TCAS II, Version 6.0, in 1990. The TTP was continued through the subsequent implementations of Versions 6.04a (1993) and Version 7.0 (1999). Voluntary reports from pilots and controllers were collected and if a technical or operational issue was indicated, ATC radar data associated with the event was also obtained. Quarterly TTP newsletters containing information on TCAS performance were distributed to the TCAS user community. The results of focused studies of performance were periodically reviewed with representatives from FAA, airlines, pilot and controller unions, and TCAS manufacturers. Over time, this resulted in modifications to the TCAS logic, enhancements to the TCAS training program, changes in operational procedures involving TCAS, and improved guidance on the use of TCAS.

Beginning in 1991, EUROCONTROL was asked to organize the operational monitoring of ACAS II in the European airspace and for European carriers. This work was conducted under the auspices of ICAO. In parallel, the UK and France conducted their own monitoring for their respective airspaces and this formed an integral part of the European monitoring of ACAS. The main source of information was pilot and controller questionnaires that were distributed to airline companies and ATC facilities.

Additionally, a procedure was in place requesting the controllers to secure radar data recordings for all reported events. These events were analyzed and the results stored in databases. A number of ACAS bulletins were published by EUROCONTROL highlighting various performance issues of significance. The results of these analysis activities along with

those from the FAA TTP were used to develop TCAS Versions 7.0 and 7.1.

In 2008, FAA established the TCAS II Operational Performance Assessment (TOPA) Program to quantitatively characterize and assess the operational performance of TCAS Version 6.04a and 7.0 units that are currently operating in the U.S. This data will also be used as a baseline to assess the performance of TCAS Version 7.1 units which are expected to begin operation by 2010-2011. The primary sources of performance data are Mode S RA downlinks and associated ATC radar surveillance data obtained through the TCAS RA Monitoring System (TRAMS) on a continuous basis. The TRAMS is being installed at twenty sites throughout the continental U.S. including the busiest terminal areas. TRAMS data, pilot and controller reports, aircraft incident databases, and, in some cases, data from airborne flight recorders and ATC voice tapes, will be used to analyze RAs associated with close encounters and problematic areas such as approaches to closely-spaced parallel runways. Significant performance issues identified by TOPA will be reviewed with the aviation community to determine probable cause and develop recommendations for improvement. TOPA findings will also be used to assist FAA and other civil aviation authorities in developing requirements for the next generation collision avoidance system.

Further information on the need for establishing operational performance monitoring programs can be found in the ICAO ACAS II Manual (Doc. 9863).

Observed Performance

The evaluation of TCAS II performance during its implementation and subsequently as documented by monitoring data and several large scale safety studies has demonstrated that this equipment provides a significant overall improvement in flight safety. Based on numerous pilot reports,

TAs have been extremely useful in visually acquiring aircraft prior to a potentially serious situation occurring. In many cases, RAs have been issued that are reported to have prevented critical near mid-air collisions and mid-air collisions from taking place.

Previous operational performance analysis has indicated that some issues related to TCAS have occurred. Significant reductions in the occurrences of many of these issues have resulted from improved TCAS logic, and improved training guidance for pilots and controllers. These issues include the following:

Clearance Deviations Resulting from TCAS RAs. Pilots sometimes deviate significantly further from their original clearance than required or desired while complying with an RA. This may be due to either over-reaction to the initial RA or delays in complying with weakened RAs. While over-reactions to TCAS RAs are not common, they can lead to loss of separation with other aircraft that were not originally involved in the encounter, or even aircraft damage and passenger injury. Additionally, data analyses and simulator trials have shown that pilots often are not aware of the RA being weakened and many pilots do not want to begin maneuvering back towards their original clearance until the RA is over and “Clear of Conflict” is annunciated.

To reduce the frequency of the large altitude displacements while responding to an RA, Version 7.0 introduced new aural annunciations to accompany the weakening RAs and provided a target vertical speed on the RA display for the weakened RA (“green arc on weakening”). Version 7.1 will change all AVSA RAs to Vertical Speed Limit (VSL) 0 fpm or LOLO RAs with a corresponding aural annunciation of “Level Off, Level Off”. Although this should serve to further reduce altitude deviations during weakened RAs, allowing only VSL 0 fpm RA will result in a modest increase in altitude clearance deviations over

Version 7.0. While unnecessary deviations from ATC clearance continue to be an important factor in the effectiveness of TCAS, the number and magnitude of these excursions have been greatly reduced over the years since TCAS was introduced.

Inadequate or Improper Coordination with ATC. Unless RAs are reported by pilots, most controllers do not have a means to determine that an RA has been issued. Thus, an RA is generally unexpected by a controller and in many cases is a disruption to his or her workload. This disruption is due to an aircraft's unanticipated deviation from the ATC clearance, use of the ATC frequency to report an RA, and the possibility of an induced conflict with a third aircraft. Pilots sometimes do not report, or are slow in reporting TCAS-related clearance deviations to the controller. This has contributed to situations where controllers have issued clearances that were in the opposite sense than that directed by the RA. The standard ICAO phraseology is sometimes not used and at times, the controller does not understand the initial RA notification from the pilot. This issue has been effectively addressed by pilot and controller training programs but deserves constant attention and continual monitoring.

Aircraft have also been observed making vertical or horizontal maneuvers based solely on the information shown on the traffic display, without visual acquisition by the flight crew and sometimes contrary to their existing ATC clearance. Such maneuvers may not be consistent with controller plans, can cause a significant degradation in the level of flight safety and may be contrary to a limitation contained in the TCAS Airplane Flight Manual Supplement. This improper use of the traffic display has been addressed via pilot training programs but more emphasis is needed.

Improper Compliance with RAs. Earlier event reports and analyses of ground surveillance radar and flight recorder data indicate that some pilots were not

responding to RAs, delaying response, or responding in the wrong direction. In some cases, there was no response or delayed response when the flight crew did not visually acquire the intruder, or misidentified or subsequently lost sight of the intruder causing potentially hazardous situations. If the intruder is also TCAS-equipped, the RAs are coordinated, and a non-response or a delayed response by one aircraft will result in the other aircraft having to maneuver further to resolve the RA. In some cases, it may also result in an aircraft maneuvering in the same vertical direction resulting in reduced separation. In addition to noncompliance, there have been instances observed where pilots responded in the wrong direction, i.e., the direction opposite to that indicated by the RA. In particular, pilots have occasionally increased their vertical rate in response to an AVSA RA instead of decreasing it. To minimize chances of opposite responses to AVSA RA, Version 7.1 changed "AVSA" RAs to "VSL 0 fpm" or "LOLO" RAs.

Incompatibilities between a TCAS RA and controller instructions have also contributed to RA noncompliance resulting in an accident or serious incident. A contributing factor in the Ueberlingen Germany mid-air was the flight crew following the controller's instructions instead of the TCAS RA. TCAS Version 7.1 incorporates a change to the sense reversal logic that reduces the risk of an accident like the one at Ueberlingen.

More recent analyses show that these issues have been greatly reduced through improved TCAS logic and pilot and controller training programs. Most cases of "no response" to an RA can be attributed to pilots having visual contact with the intruder or being on parallel approaches to runways during VFR operations and visual separation procedures. Wrong direction responses, though now rarely reported, must always be avoided. In summary, the safety benefits provided by TCAS decrease significantly when pilots do

not comply with RAs as the TCAS logic expects.

Incompatibility between TCAS and ATC Procedures or Airspace Design.

Operational experience, monitoring studies and pilot/controller reports have shown that incompatibilities between TCAS and the ATC system can occur under the conditions described below.

Aircraft leveling off at 1,000 ft above or below conflicting traffic that is level may result in RAs being issued to the level aircraft. These RAs are triggered because the climbing or descending aircraft maintains high vertical speeds when approaching the cleared altitude or flight level. The CAS logic contains algorithms that will recognize this encounter geometry and will delay the issuance of the RA to the level aircraft by up to five (5) seconds to allow TCAS to detect the initiation of the level off maneuver by the intruder.

Version 6.04a of the logic included these algorithms at lower altitudes and these have been effective in reducing the frequency of this type of RA. Version 7.0 is required for operations in RVSM airspace since it expands the use of this logic to higher altitudes to address the occurrence of these types of RAs in the en route airspace structure. In spite of these improvements, RAs related to high vertical rates still occur. Therefore, to avoid these types of RAs, pilots are encouraged to reduce their vertical rate when approaching their cleared altitude, particularly when there is known traffic at an adjacent clearance altitude. The ICAO ACAS Manual (ICAO Doc 9863) and the AIM provide the following guidance on vertical rate reduction to reduce TCAS RAs:

"When safe, practical, and in accordance with the carrier's approved operating procedures, pilots should limit vertical speeds to 1,500 fpm or less when within 2,000 feet of assigned altitudes. This procedure will reduce the frequency of unnecessary RAs and be in conformance

with the ICAO guidance contained in PANS-OPS."

TCAS RAs are frequently generated during VFR operations and visual separation procedures since the TCAS logic does not consider the horizontal and vertical separations that occur in these situations. TCAS RAs may occur during approaches to airfields conducting VFR pattern operations. Also, altitude crossing clearances issued by a controller based on maintaining visual separation may result in RAs being issued, particularly if one of the aircraft is level. Finally, nuisance RAs are often generated during visual approaches to closely spaced parallel runways; especially those separated by less than DMOD (0.20 or 0.35nmi at lower altitudes).

In summary, there are certain incompatibilities between TCAS and ATC procedures or airspace design that exist today that will not change with Version 7.1. To mitigate their effects, improvements in airspace and procedure development as well as flight training and procedures will be needed.

Abnormal TCAS Alerts. Previous TCAS reports showed occurrences of TCAS alerts where there was no traffic and some cases where either own or intruder was at an incorrect altitude. Alerts where there is no traffic, or phantoms, have been generated by improper emissions from different types of ground stations (often during equipment testing) or by faulty installation or functioning of the TCAS equipment. The improper altitude reporting by either own or intruder aircraft has been traced to the aircraft's air data or transponder systems. These issues have been greatly reduced and since they can be easily corrected once identified, prompt reporting of these abnormalities is important. Monitoring of transponder performance will continue since proper operation of transponders is essential to maintaining the level of safety expected from TCAS.

Summary

TCAS II is a last resort airborne system designed to prevent mid-air collisions and significantly reduce near mid-air collisions between aircraft. From the early 1990's through 2000 a number of countries issued a mandate for the carriage of TCAS II. In 2001, ICAO mandated the carriage of TCAS II by all member states by January 1, 2003 for turbo-powered airplanes with a maximum take-off weight of more than 15,000 kg or authorized to carry more than 30 passengers. The mandate was extended to January 1, 2005 for turbo-powered airplanes with a maximum take-off weight of more than 5700 kg or authorized to carry more than 19 passengers.

It is estimated that currently there are approximately 25,000 TCAS II units operating worldwide on airline, cargo, business, and government, including military, aircraft. Accident and incident statistics have validated the safety benefit provided by TCAS II. It must be stressed however that TCAS II cannot resolve every near mid-air collision and may induce a near mid-air collision if certain combinations of events occur. Consequently, it is essential that ATC procedures are designed to ensure flight safety without any reliance upon the use of TCAS II and that both pilots and controllers are well versed in the operational capabilities and limitations of TCAS II.

Over the years, the aviation industry has worked together to develop, test, certify, and install TCAS II Versions 6.04a (1993) and 7.0 (1999). These groups are now involved with implementing Version 7.1. Operational performance monitoring programs conducted in the U.S., Europe, and in other areas have been effective in identifying and correcting deficiencies in the design and use of TCAS II culminating in Version 7.1. These programs will be relied on to provide the information necessary to assess the safety benefit and acceptability to pilots, controllers and the ATC system provided by Version 7.1.

For more information on TCAS capabilities and requirements, contact the FAA TCAS Program Office, AJP-67, 800 Independence Avenue, S.W., Washington, D.C. 20591.

Abbreviations

ACAS	Airborne Collision Avoidance System
ACO	Aircraft Certification Office
ADC	Air Data Computer
ADS-B	Automatic Dependent Surveillance - Broadcast
AEEC	Airline Electronic Engineering Committee
AGL	Above Ground Level
AIC	Aeronautical Information Circular
AIM	Airman's Information Manual
AIP	Aeronautical Information Publication
ALIM	Altitude Limit
ATC	Air Traffic Control
ATCRBS	Air Traffic Control Radar Beacon System
BCAS	Beacon Collision Avoidance System
CAA	Civil Aviation Authority
CAS	Collision Avoidance System
CPA	Closest Point of Approach
DMOD	Distance MODification
DME	Distance Measuring Equipment
DMTL	Dynamic Minimum Triggering Level
EATCHIP	European Air Traffic Control Harmonization and Integration Program
EFIS	Electronic Flight Instrument System
EICAS	Engine Indication and Crew Alerting System
FAA	Federal Aviation Administration
FAR	Federal Aviation Regulations
FL	Flight Level
FMS	Flight Management System
FRUIT	False Replies from Unsynchronized Interrogator Transmissions
ft	feet
fpm	feet per minute
GPWS	Ground Proximity Warning System
HMD	Horizontal Miss Distance
HUD	Head Up Display
ICAO	International Civil Aviation Organization
IFR	Instrument Flight Rules
IVSI	Instantaneous Vertical Speed Indicator
JCAB	Japan Civil Aviation Bureau

CIAS	Knots Indicated Airspeed
LCD	Liquid Crystal Display
LED	Light Emitting Diode
MDF	Miss Distance Filtering
MHz	Megahertz
MOPS	Minimum Operational Performance Standards
MTL	Minimum Triggering Level
NAS	National Airspace System
ND	Navigation Display
NMAC	Near-Midair-Collision
nmi	Nautical Miles
PANS	Procedures for Air Navigation Services
PFD	Primary Flight Display
RA	Resolution Advisory
RVSM	Reduced Vertical Separation Minimums
SARPs	Standards and Recommended Practices
SICASP	SSR Improvement and Collision Avoidance System Panel
SL	Sensitivity Level
SSR	Secondary Surveillance Radar
STC	Supplemental Type Certificate
TA	Traffic Advisory
TCAS	Traffic alert and Collision Avoidance System
TFC	Traffic
TSO	Technical Standard Order
VFR	Visual Flight Rules
VSI	Vertical Speed Indicator
WS	Whisper Shout
XPDR	Transponder

Glossary

ALTITUDE, RELATIVE: The difference in altitude between own aircraft and a target aircraft. The value is positive when the target is higher and negative when the target is lower.

BEARING: The angle of the target aircraft in the horizontal plane, measure clockwise from the longitudinal axis of the own aircraft.

CAS: Generic term for collision avoidance system.

COORDINATION: Data communications between TCAS-equipped aircraft to ensure that they will provide complementary, i.e., non-conflicting RAs.

CPA: Closest point of approach as computed from a threat's range and range rate.

CROSSOVER: Encounters in which own aircraft and the threat aircraft are projected to cross in altitude prior to reaching CPA.

ESCAPE MANEUVER: See resolution maneuver.

FRUIT: See Garble, Non-Synchronous

GARBLE, NON-SYNCHRONOUS: Reply pulses received from a transponder that is being interrogated from some other source. Also called fruit.

GARBLE, SYNCHRONOUS: An overlap of the reply pulses received from two or more transponders answering the same interrogation.

INTRUDER: A target that has satisfied the traffic detection criteria.

OWN AIRCRAFT: The TCAS-equipped reference aircraft.

PROXIMITY TARGET: Any target that is less than 6 nmi in range and within $\pm 1,200$ feet vertically, but that does not meet the intruder or threat criteria.

RA: Resolution advisory. An indication given by TCAS II to a flight crew that a vertical maneuver should, or in some cases should not, be performed to attain or maintain safe separation from a threat.

RESOLUTION MANEUVER: Maneuver in the vertical plane resulting from compliance with an RA.

SENSE REVERSAL: Encounter in which it is necessary to reverse the sense of the original RA to avoid a threat. This is most likely to occur when an unequipped threat changes its vertical rate in a direction that thwarts the original RA.

SL: Sensitivity Level. A value used in defining the size of the protected volume around own aircraft.

SQUITTER: Spontaneous transmission generated once per second by Mode S transponders.

TA: Traffic Advisory. An indication given by TCAS to the pilot when an aircraft has entered, or is projected to enter, the protected volume around the own aircraft.

TA-ONLY MODE: A TCAS mode of operation in which TAs are displayed when required, but all RAs are inhibited.

TARGET: An aircraft that is being tracked by a TCAS-equipped aircraft.

TCAS: Traffic Alert and Collision Avoidance System.

THREAT: An intruder that has satisfied the threat detection criteria and thus requires an RA to be issued.

TRANSPONDER, MODE C: ATC transponder that replies with both identification and altitude data. If the transponder does not have an interface with an encoding altimeter source, only the altitude bracket pulses are transmitted and no altitude data are provided.

TRANSPONDER, MODE S: ATC transponder that replies to an interrogation containing its own, unique 24-bit selective address, and typically with altitude data.

VSI: Vertical speed indicator.

WHISPER-SHOUT (WS): A method of controlling synchronous garble from ATCRBS transponders through the combined use of variable power levels and suppression pulses.

Bibliography

Additional information on the performance, design, and requirements for TCAS can be found in the following documents.

- RTCA/DO-185B, Minimum Operational Performance Standards for Traffic Alert and Collision Avoidance System (TCAS II) Airborne Equipment
- RTCA/DO-300, Minimum Operational Performance Standards for Traffic Alert and Collision Avoidance System (TCAS II) For TCAS II Hybrid Surveillance.
- FAA Technical Standard Order C-119c, Traffic Alert and Collision Avoidance System (TCAS) Airborne Equipment
- FAA Advisory Circular 20-131, Airworthiness Approval of Traffic Alert and Collision Avoidance System (TCAS II) and Mode S Transponders
- FAA Advisory Circular 120-55C, Air Carrier Operational Approval and Use of TCAS II
- ICAO Annex 10, Standards and Recommended Practices and Guidance Material for Airborne Collision Avoidance Systems
- AEEC/ARINC Characteristic 735A, Traffic Alert and Collision Avoidance System (TCAS II)
- AEEC/ARINC Characteristic 718B, Mark 2 Air Traffic Control Transponder (ATCRBS/ Mode S)
- RTCA/DO-197A, Minimum Operational Performance Standards for an Active Traffic Alert and Collision Avoidance System (Active TCAS I)
- FAA Technical Standard Order C-118, Traffic Alert and Collision Avoidance System (TCAS I) Airborne Equipment
- Doc. 4444 of ICAO - PANS-ATM, "Procedures for Air Navigation Services – Rules of the Air and Air Traffic Services"
- Doc. 8168 of ICAO – PANS-OPS, "Procedures for Air Navigation Services – Aircraft"
- Doc. 9863 of ICAO, "Airborne Collision Avoidance System II (ACAS II) Manual"